

ISOMETRIC VIEW

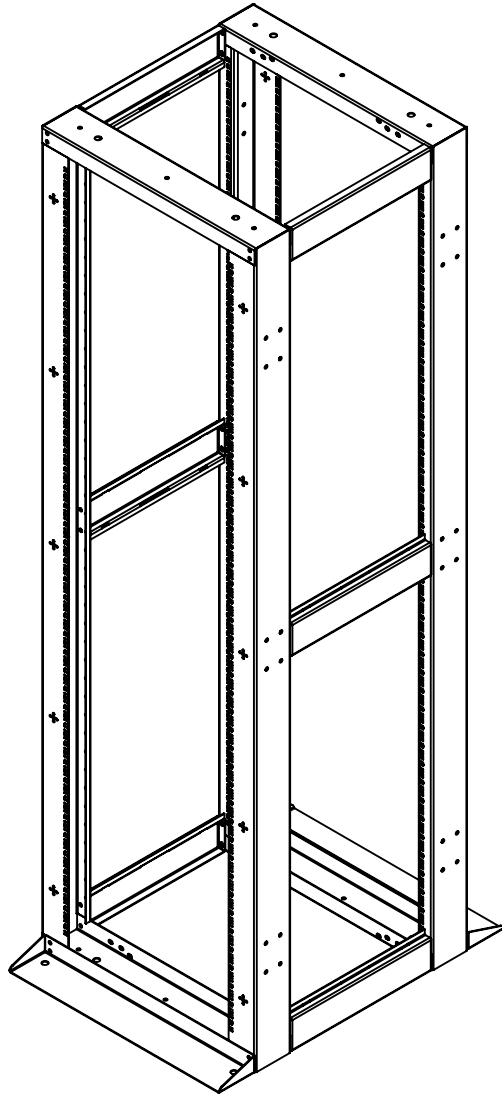

EXPLODE VIEW

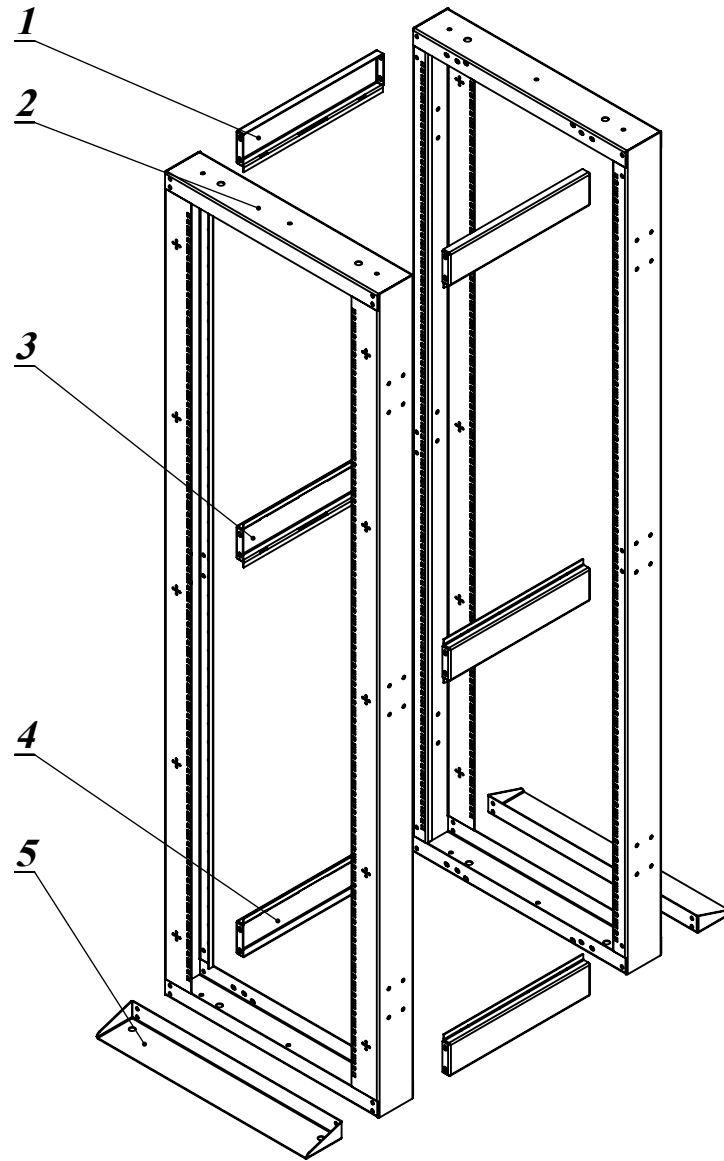

5	Base support	2	2.0	
4	Bottom Support	2	2.0	
3	Middle Support	2	2.0	
2	Frame	2	2.0	
1	Top Support	2	2.0	
Item	Name	Q'TY	Thick	Description



ANH MINH TECHNOLOGY COMPANY LIMITED-AMTEC CO.,LTD
 17/3 Binh Quoi, Binh Chuan, Thuan An, Binh Duong, Viet Nam
 Tel: (84-650) 3612177 Fax: (84-650) 3612178
 Email: info@amtec.com.vn Web: www.amtec.com.vn

Customer:

-

Drawing title:

AMTEC SMART-NET 4 POST OPEN RACK 42U 600x600

Part No:

AMS-O42-4-60

Design by: NGUYỄN XUÂN HÙNG Date: 10-03-2016

Checked by: LÊ HOÀNG TUẤN Date: 10-03-2016

Material: SPCC \varnothing 2

Scale: 1:15

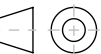

Sheet No:

Drawn by: NGUYỄN XUÂN HÙNG Date: 10-03-2016

Approved by: PHAN QUANG ĐỨC Date: 10-03-2016

Qty/Job: -

Unit: mm

02

File name:

-

Drawing No:

01

FRONT VIEW

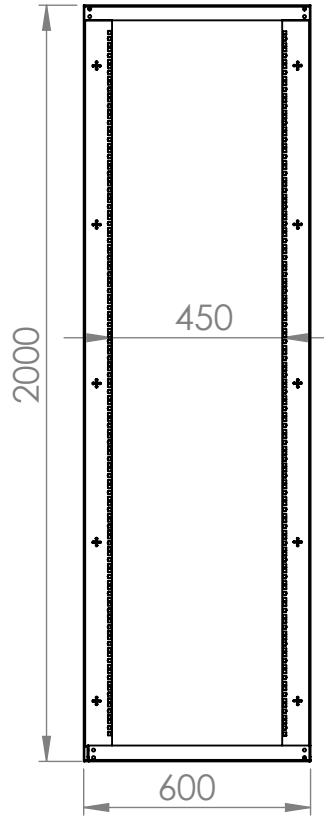

SIDE VIEW

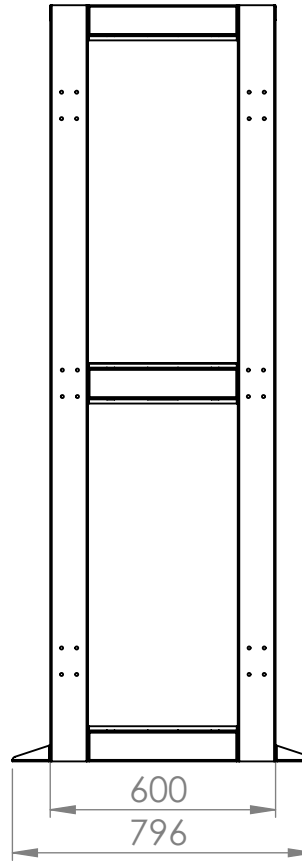

ISOMETRIC VIEW

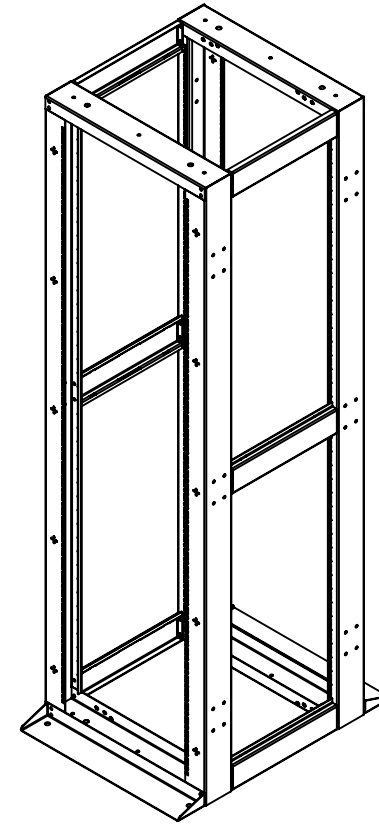

TOP VIEW

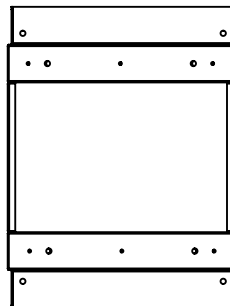

BOTTOM VIEW

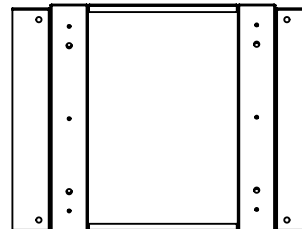

ANH MINH TECHNOLOGY COMPANY LIMITED-AMTEC CO.,LTD
 17/3 Binh Quoi, Binh Chuan, Thuan An, Binh Duong, Viet Nam
 Tel: (84-650) 3612177 Fax: (84-650) 3612178
 Email: info@amtec.com.vn Web: www.amtec.com.vn

Customer:	-	Drawing title:	AMTEC SMART- NET 4 POST OPEN RACK 42U 600x600		Part No:	AMS-O42-4-60	
Design by:	NGUYỄN XUÂN HÙNG	Date:	10-03-2016	Checked by:	LÊ HOÀNG TUẤN	Date:	10-03-2016
Drawn by:	NGUYỄN XUÂN HÙNG	Date:	10-03-2016	Approved by:	PHAN QUANG ĐỨC	Date:	10-03-2016
File name:	-	Material:	SPCC	Scale:	1:20	Unit:	mm
		Qty/Job:	-	Drawing No:	02		

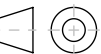

Sheet No:
02