

**FRONT&RIGHT VIEW**

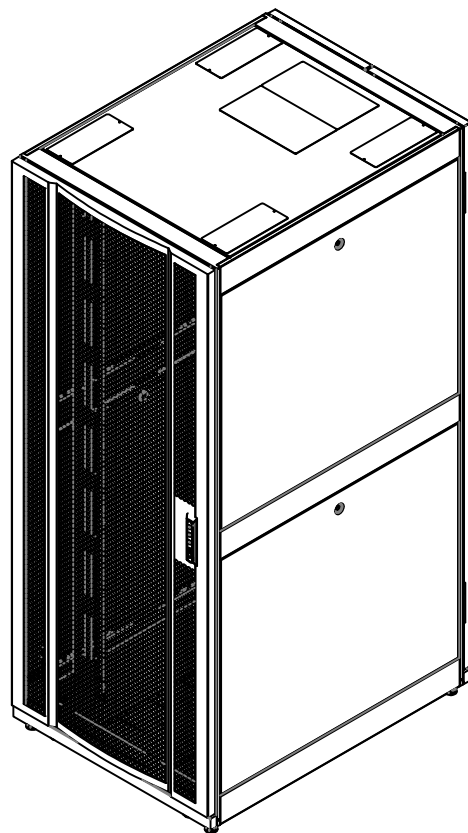

**REAR&LEFT VIEW**

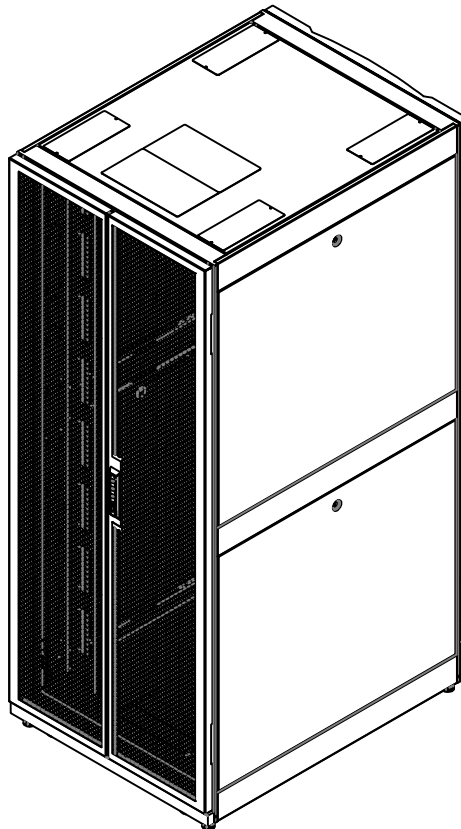

**Thông số kỹ thuật:**

1	Các tiêu chuẩn	. ANSI/EIA 310-D, phần A . DIN 41494. . BS 5954 phần 2. . IEC 60297-1, IEC 60297-2 . RoHS. . IP20.
2	Độ dày thép	. Khung 2mm. . Thanh treo thiết bị 2mm. . Cửa trước và sau 1.2mm. . Cửa hông 1mm. . Đế che 1,5mm . Thanh bật nguồn/Quản lý cáp 1mm. . Thanh nối khung trước&sau 2mm.
3	Tải trọng	. Trên các bánh xe 1000 kg. . Trên các chân đế 1500 kg. . Tải trọng trên nóc 80 kg. . Tải trọng trên đế 80 kg.
4	Màu sơn	Sơn tĩnh điện màu đen
5	Độ thông thoáng	Cửa lưới lục giác trước&sau thông thoáng >80%



ANH MINH TECHNOLOGY COMPANY LIMITED-AMTEC CO.,LTD  
17/3, Binh Quoi A, Binh Chuan, Thuan An, Binh Duong, Viet Nam  
Tel: (84-274) 3612177 Fax: (84-274) 3612178  
Email: info@amtec.com.vn Web: www.amtec.com.vn

<b>Customer:</b>	-	<b>Drawing title:</b>	AMTEC ROYAL-DC DATACENTER CABINET 36U 800x1000		<b>Part No:</b>	AMDC36-8100							
<b>Design by:</b>	Nguyễn Xuân Hùng	<b>Date:</b>	06-03-2019	<b>Checked by:</b>	Lê Hoàng Tuấn	<b>Date:</b>	06-03-2019	<b>Material:</b>	SPCC t= 1 to 2	<b>Scale:</b>	1:20	<b>Sheet No:</b>	07
<b>Drawn by:</b>	Nguyễn Xuân Hùng	<b>Date:</b>	06-03-2019	<b>Approved by:</b>	Phan Quang Đức	<b>Date:</b>	06-03-2019	<b>Qty/Job:</b>	-	<b>Unit:</b>	mm		
<b>File name:</b>								<b>Drawing No:</b>	01				

# EXPLODE VIEW

(Thiết kế Modular dễ dàng vận hành và thao tác)

②

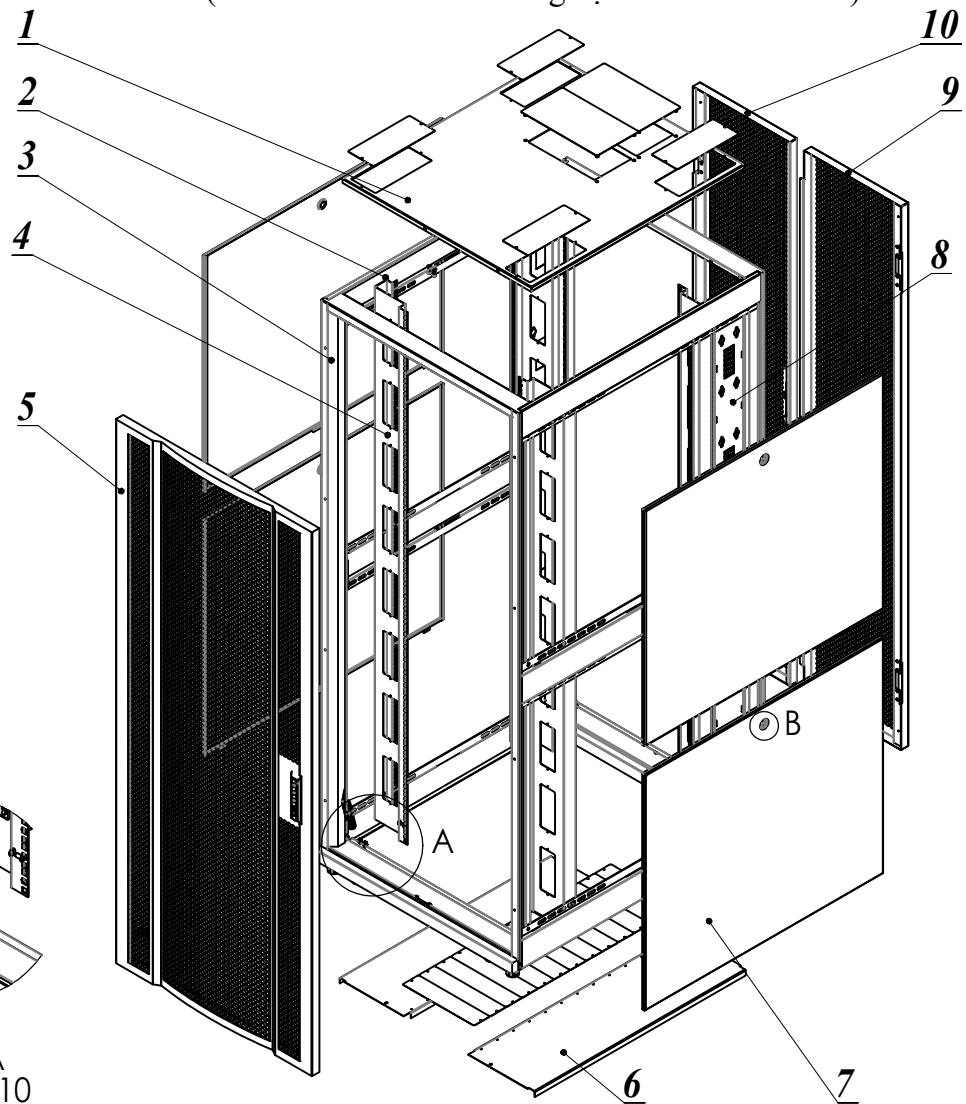

Vị trí tiếp địa  
(2 Vị trí cửa trước,  
2 vị trí cửa sau)

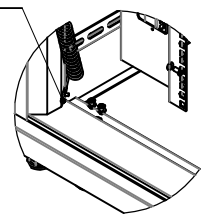

DETAIL A  
SCALE 1 : 10

Khóa cửa hông  
(4 cánh dùng chung chìa)

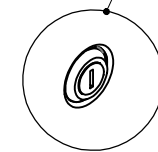

DETAIL B  
SCALE 1 : 5

10	Rear door right	1	1.2	>80% perforated
9	Rear door left	1	1.2	>80% perforated
8	Cable management	2	1.0	Up to 4 PDU APC
7	Side door	4	1.0	
6	Base	2	1.5	
5	Front door	1	1.2	>80% perforated
4	Profile bar	4	2.0	
3	Frame	4	2.0	
2	Support bar	6	2.0	
1	Top roof	1	1.2	
Item	Name	Q'TY	Thick	Description



ANH MINH TECHNOLOGY COMPANY LIMITED-AMTEC CO.,LTD  
17/3, Binh Quoi A, Binh Chuan, Thuan An, Binh Duong, Viet Nam  
Tel: (84-274) 3612177 Fax: (84-274) 3612178  
Email: info@amtec.com.vn Web: www.amtec.com.vn

Customer: -

Drawing title:  
AMTEC ROYAL-DC DATACENTER CABINET  
36U 800x1000

Part No:  
AMDC36-8100



Design by: Nguyễn Xuân Hùng Date: 06-03-2019

Checked by: Lê Hoàng Tuấn Date: 06-03-2019

Material: SPCC t= 1 to 2

Scale: 1:20

Sheet No:

Drawn by: Nguyễn Xuân Hùng Date: 06-03-2019

Approved by: Phan Quang Đức Date: 06-03-2019

Qty/Job: -

Unit: mm

07

File name:

Drawing No: 02

**FRONT VIEW**

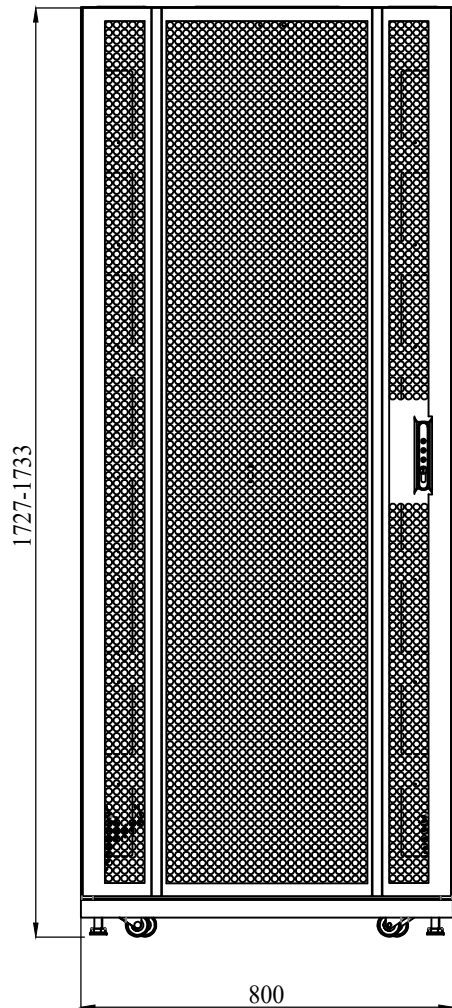

**FRONT VIEW  
(REMOVED DOOR)**

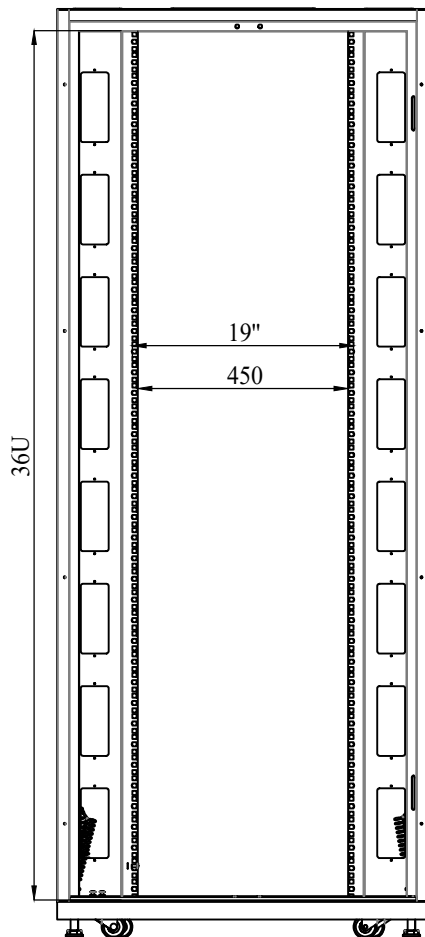

**REAR VIEW**

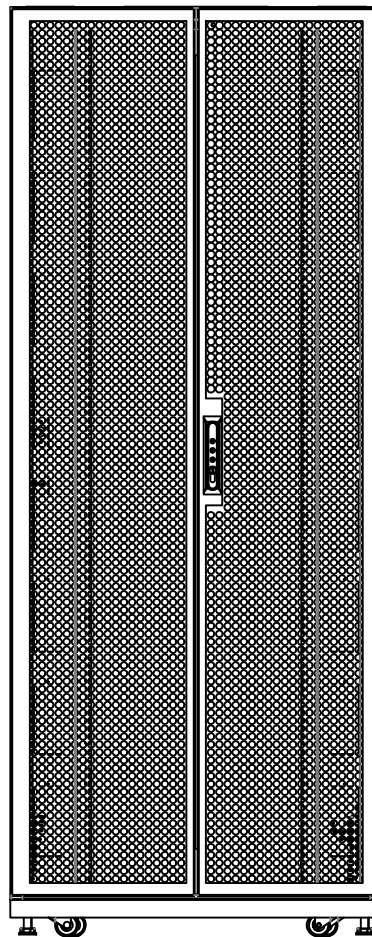

**SIDE VIEW**

3

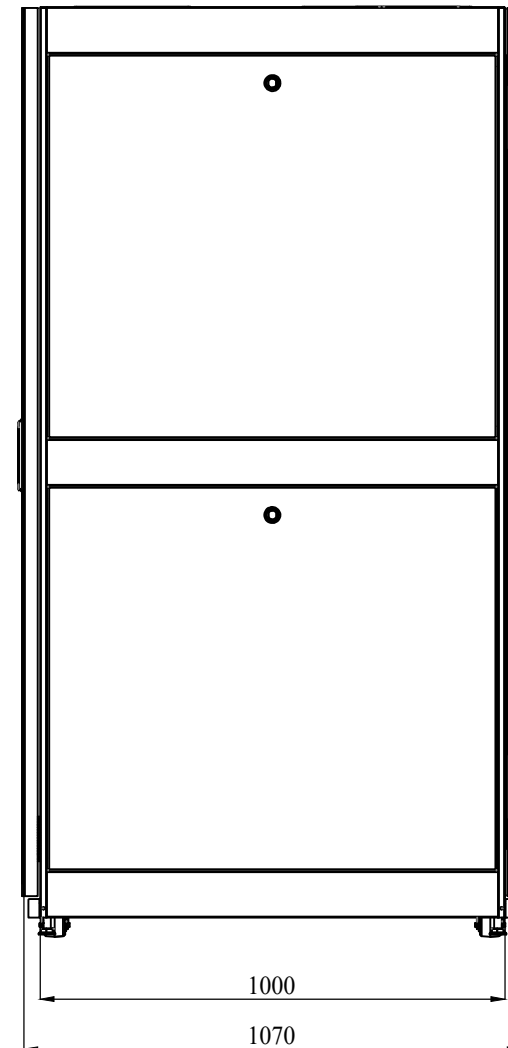

ANH MINH TECHNOLOGY COMPANY LIMITED-AMTEC CO.,LTD  
 17/3, Binh Quoi A, Binh Chuan, Thuan An, Binh Duong, Viet Nam  
 Tel: (84-274) 3612177 Fax: (84-274) 3612178  
 Email: info@amtec.com.vn Web: www.amtec.com.vn

**Customer:** -  
**Design by:** Nguyễn Xuân Hùng **Date:** 06-03-2019  
**Drawn by:** Nguyễn Xuân Hùng **Date:** 06-03-2019  
**File name:**

**Drawing title:**  
 AMTEC ROYAL-DC DATACENTER CABINET  
 36U 800x1000  
**Checked by:** Lê Hoàng Tuấn **Date:** 06-03-2019  
**Approved by:** Phan Quang Đức **Date:** 06-03-2019

**Part No:** AMDC42-8100  
**Material:** SPCC t=1.0 2 **Scale:** 1:15  
**Qty/Job:** - **Unit:** mm  
**Drawing No:** 03

**Sheet No:** 07

**TOP VIEW**

**BOTTOM VIEW**

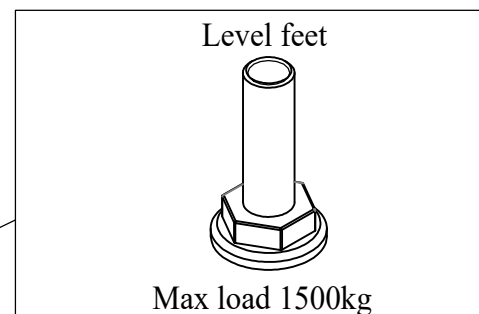
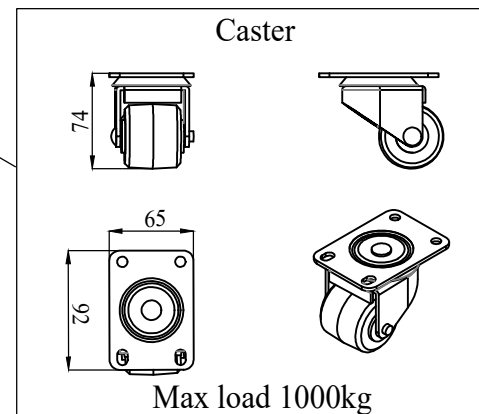
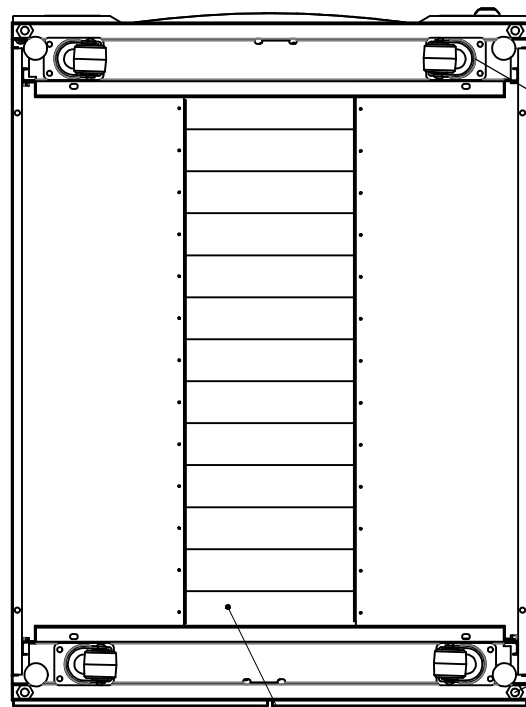
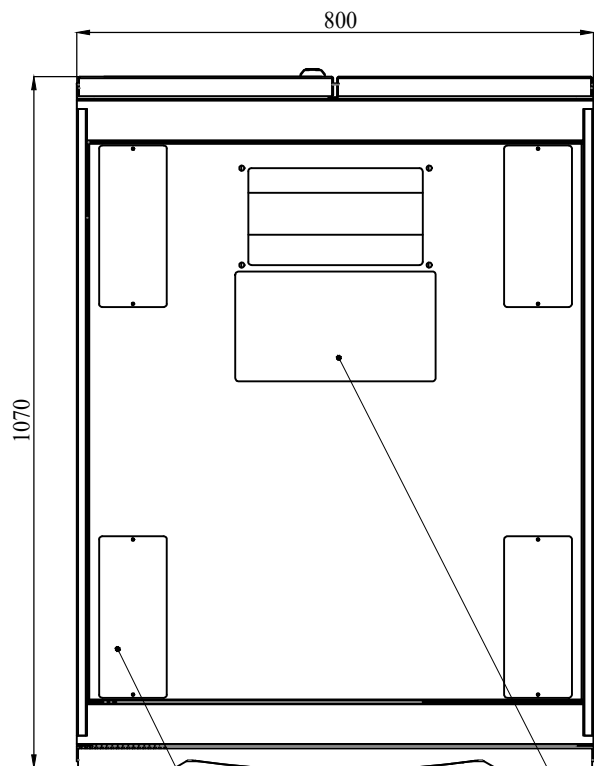

Cable hole 100x240 (4x)

Cable hole 150x270 (2x)

Cable hole 60x270



ANH MINH TECHNOLOGY COMPANY LIMITED-AMTEC CO.,LTD  
 17/3, Binh Quoi A, Binh Chuan, Thuan An, Binh Duong, Viet Nam  
 Tel: (84-274) 3612177 Fax: (84-274) 3612178  
 Email: info@amtec.com.vn Web: www.amtec.com.vn

<b>Customer:</b>	-	<b>Drawing title:</b>	AMTEC ROYAL-DC DATACENTER CABINET 36U 800x1000		<b>Part No:</b>	AMDC36-8100								
<b>Design by:</b>	Nguyễn Xuân Hùng	<b>Date:</b>	06-03-2019	<b>Checked by:</b>	Lê Hoàng Tuấn	<b>Date:</b>	06-03-2019		<b>Material:</b>	SPCC t=1 to 2	<b>Scale:</b>	1:10	<b>Sheet No:</b>	07
<b>Drawn by:</b>	Nguyễn Xuân Hùng	<b>Date:</b>	06-03-2019	<b>Approved by:</b>	Phan Quang Đức	<b>Date:</b>	06-03-2019		<b>Qty/Job:</b>	-	<b>Unit:</b>	mm		
<b>File name:</b>									<b>Drawing No:</b>	04				

# DETAIL ITEM: 5-9-10

5

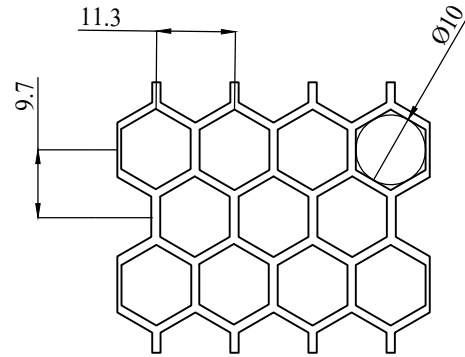
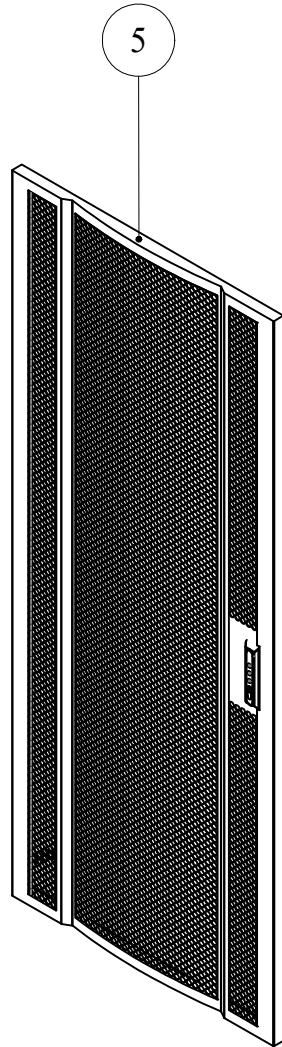

>80% HEXAGON PERFORATED DOOR

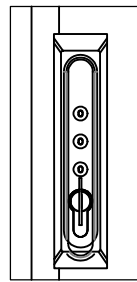

SWINGHANDLE KEY

9

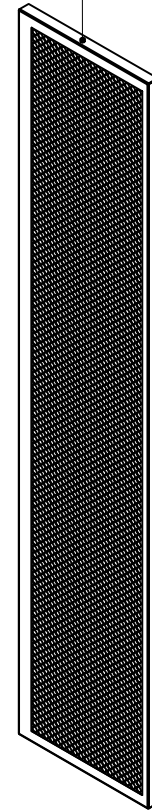

10

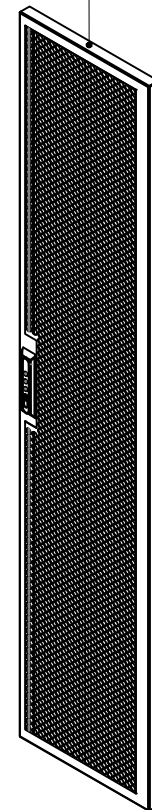

ANH MINH TECHNOLOGY COMPANY LIMITED-AMTEC CO.,LTD  
 17/3, Binh Quoi A, Binh Chuan, Thuan An, Binh Duong, Viet Nam  
 Tel: (84-274) 3612177 Fax: (84-274) 3612178  
 Email: info@amtec.com.vn Web: www.amtec.com.vn

<b>Customer:</b>	-
<b>Design by:</b>	Nguyễn Xuân Hùng
<b>Date:</b>	06-03-2019
<b>Drawn by:</b>	Nguyễn Xuân Hùng
<b>Date:</b>	06-03-2019
<b>File name:</b>	

<b>Drawing title:</b>	AMTEC ROYAL-DC DATACENTER CABINET 36U 800x1000
<b>Checked by:</b>	Lê Hoàng Tuấn
<b>Date:</b>	06-03-2019
<b>Approved by:</b>	Phan Quang Đức
<b>Date:</b>	06-03-2019

<b>Part No:</b>	AMDC36-8100
<b>Material:</b>	SPCC t=1 to 2
<b>Scale:</b>	1:15
<b>Qty/Job:</b>	-
<b>Unit:</b>	mm
<b>Drawing No:</b>	05



**Sheet No:**  
07

# DETAIL ITEM: 3-4

6

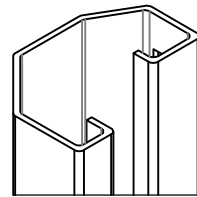
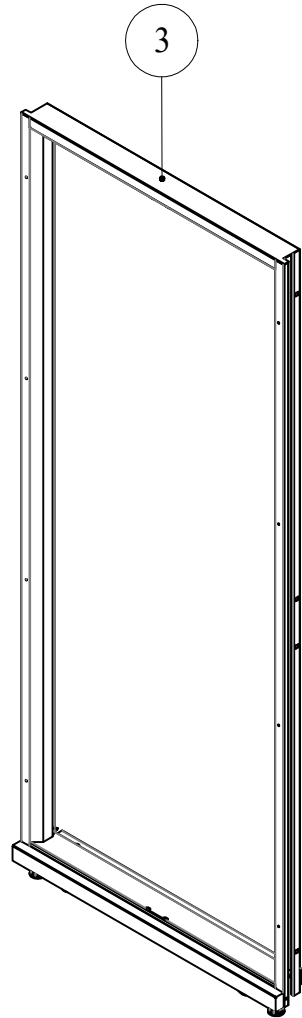

XTRUK 9 SIDES  
MAX LOAD 1500kg

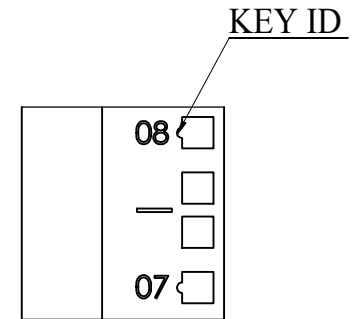
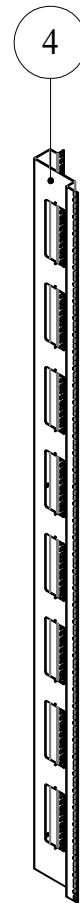

MOUNTING PROFILE  
WITH KEY ID&U-HIGH  
NUMBERING

Thanh bắt thiết bị 6 cạnh vững chắc  
và được đánh số rõ ràng từng U từ thấp đến cao



ANH MINH TECHNOLOGY COMPANY LIMITED-AMTEC CO.,LTD  
17/3, Binh Quoi A, Binh Chuan, Thuan An, Binh Duong, Viet Nam  
Tel: (84-274) 3612177 Fax: (84-274) 3612178  
Email: info@amtec.com.vn Web: www.amtec.com.vn

<b>Customer:</b>	-	<b>Drawing title:</b>	AMTEC ROYAL-DC DATACENTER CABINET 36U 800x1000		<b>Part No:</b>	AMDC36-8100							
<b>Design by:</b>	Nguyễn Xuân Hùng	<b>Date:</b>	06-03-2019	<b>Checked by:</b>	Lê Hoàng Tuấn	<b>Date:</b>	06-03-2019		<b>Material:</b>	SPCC t=1 to 2	<b>Scale:</b>	1:15	<b>Sheet No:</b>
<b>Drawn by:</b>	Nguyễn Xuân Hùng	<b>Date:</b>	06-03-2019	<b>Approved by:</b>	Phan Quang Đức	<b>Date:</b>	06-03-2019	<b>Qty/Job:</b>	-	<b>Unit:</b>	mm		
<b>File name:</b>				<b>Drawing No:</b>	06								

## ISOMETRIC VIEW

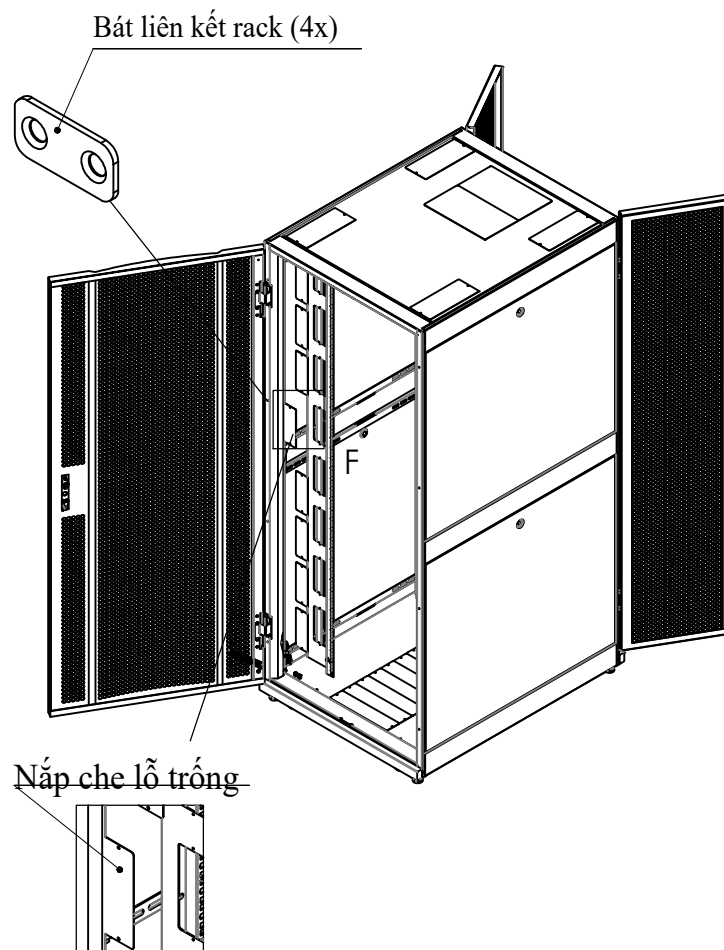

DETAIL F  
SCALE 1 : 10

## TOP VIEW

7

Góc mở cửa trước và sau 120 độ

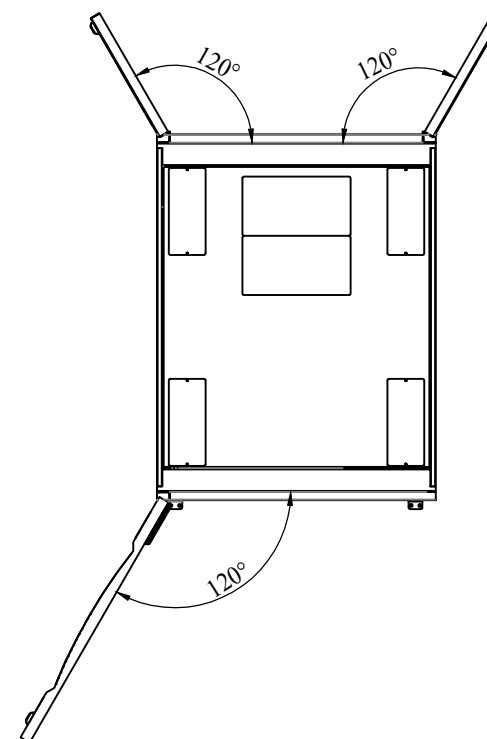

ANH MINH TECHNOLOGY COMPANY LIMITED-AMTEC CO.,LTD  
17/3, Binh Quoi A, Binh Chuan, Thuan An, Binh Duong, Viet Nam  
Tel: (84-274) 3612177 Fax: (84-274) 3612178  
Email: info@amtec.com.vn Web: www.amtec.com.vn

<b>Customer:</b>	-
<b>Design by:</b>	Nguyễn Xuân Hùng
<b>Drawn by:</b>	Nguyễn Xuân Hùng
<b>File name:</b>	

<b>Drawing title:</b>	AMTEC ROYAL-DC DATACENTER CABINET 36U 800x1000
<b>Checked by:</b>	Lê Hoàng Tuấn
<b>Approved by:</b>	Phan Quang Đức

<b>Part No:</b>	AMDC36-8100
<b>Material:</b>	SPCC t=1 to 2
<b>Qty/Job:</b>	-
<b>Drawing No:</b>	07

<b>Scale:</b>	1:25
<b>Unit:</b>	mm
<b>Sheet No:</b>	07