

FRONT&RIGHT VIEW

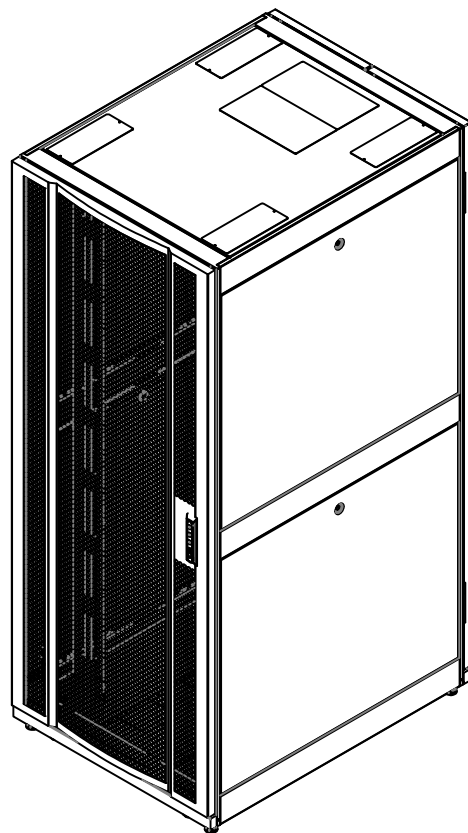

REAR&LEFT VIEW

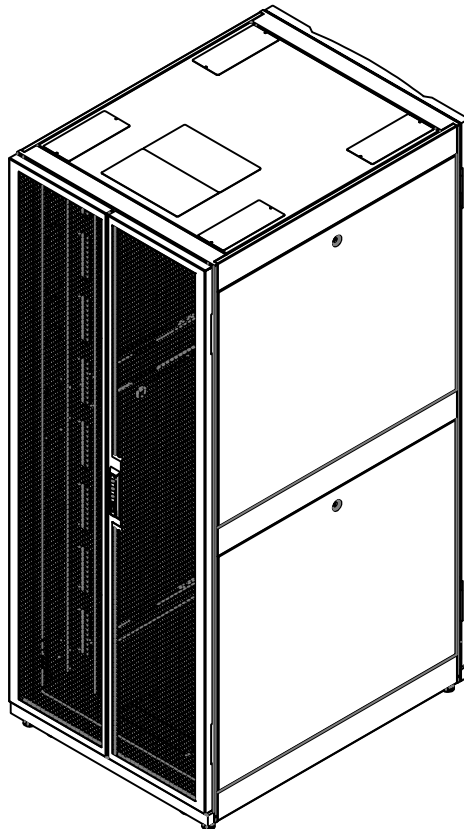

Thông số kỹ thuật:

1	Các tiêu chuẩn	. ANSI/EIA 310-D, phần A . DIN 41494. . BS 5954 phần 2. . IEC 60297-1, IEC 60297-2 . RoHS. . IP20.
2	Độ dày thép	. Khung 2mm. . Thanh treo thiết bị 2mm. . Cửa trước và sau 1.2mm. . Cửa hông 1mm. . Đế che 1,5mm . Thanh bật nguồn/Quản lý cáp 1mm. . Thanh nổi khung trước&sau 2mm.
3	Tải trọng	. Trên các bánh xe 1000 kg. . Trên các chân đế 1500 kg. . Tải trọng trên nóc 80 kg. . Tải trọng trên đế 80 kg.
4	Màu sơn	Sơn tĩnh điện màu đen
5	Độ thông thoáng	Cửa lưới lục giác trước&sau thông thoáng >80%



ANH MINH TECHNOLOGY COMPANY LIMITED-AMTEC CO.,LTD
17/3, Binh Quoi A, Binh Chuan, Thuan An, Binh Duong, Viet Nam
Tel: (84-274) 3612177 Fax: (84-274) 3612178
Email: info@amtec.com.vn Web: www.amtec.com.vn

Customer:	-	Drawing title:	AMTEC ROYAL-DC DATACENTER CABINET 48U 800x1000		Part No:	AMDC48-8100							
Design by:	Nguyễn Xuân Hùng	Date:	06-03-2019	Checked by:	Lê Hoàng Tuấn	Date:	06-03-2019		Material:	SPCC $t=1$ to 2	Scale:	1:20	Sheet No:
Drawn by:	Nguyễn Xuân Hùng	Date:	06-03-2019	Approved by:	Phan Quang Đức	Date:	06-03-2019	Qty/Job:	-	Unit:	mm		
File name:							Drawing No:	01					

EXPLODE VIEW

(Thiết kế Modular dễ dàng vận hành và thao tác)

②

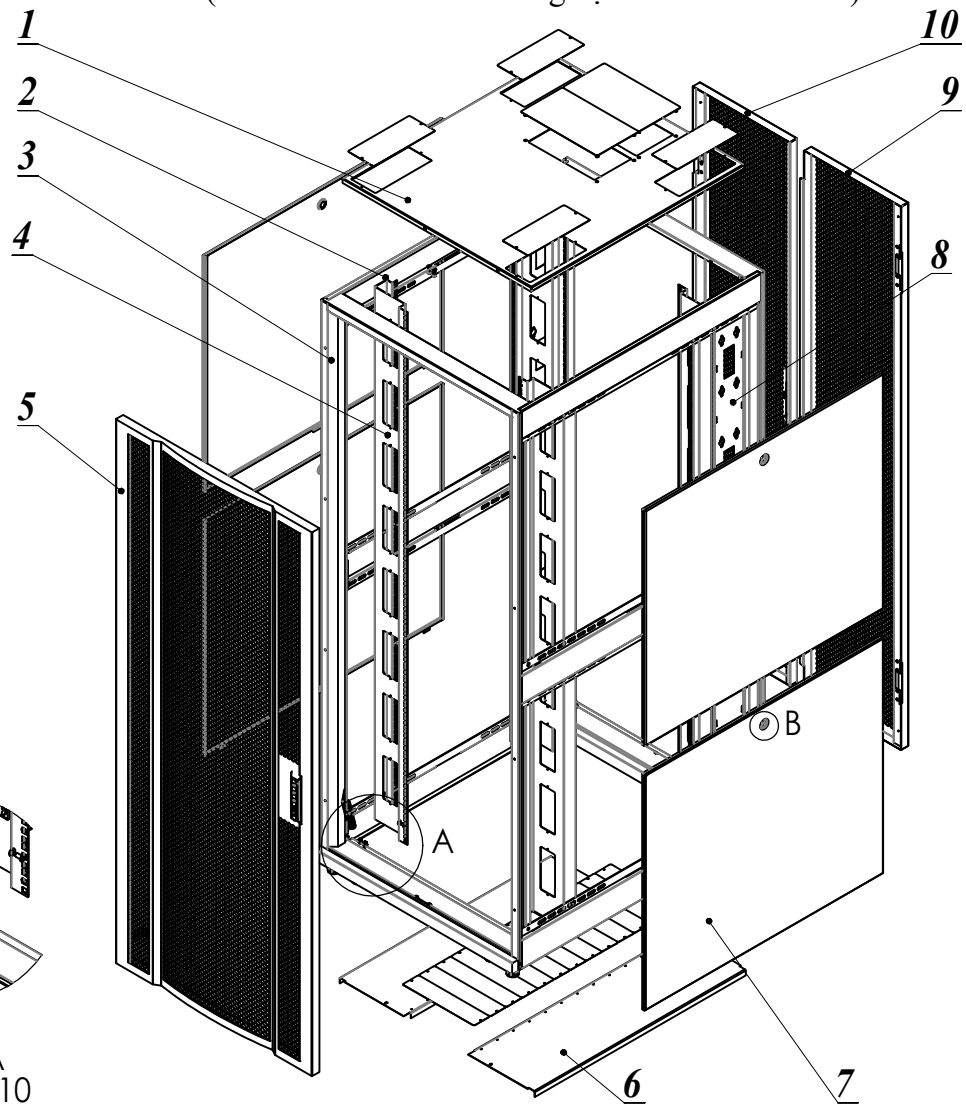

Vị trí tiếp địa
(2 Vị trí cửa trước,
2 vị trí cửa sau)

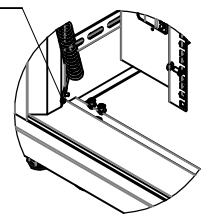

DETAIL A
SCALE 1 : 10

Khóa cửa hông
(4 cánh dùng chung chìa)

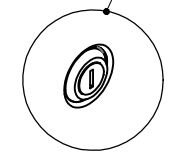

DETAIL B
SCALE 1 : 5

10	Rear door right	1	1.2	>80% perforated
9	Rear door left	1	1.2	>80% perforated
8	Cable management	2	1.0	Up to 4 PDU APC
7	Side door	4	1.0	
6	Base	2	1.5	
5	Front door	1	1.2	>80% perforated
4	Profile bar	4	2.0	
3	Frame	4	2.0	
2	Support bar	6	2.0	
1	Top roof	1	1.2	
Item	Name	Q'TY	Thick	Description



ANH MINH TECHNOLOGY COMPANY LIMITED-AMTEC CO.,LTD
17/3, Binh Quoi A, Binh Chuan, Thuan An, Binh Duong, Viet Nam
Tel: (84-274) 3612177 Fax: (84-274) 3612178
Email: info@amtec.com.vn Web: www.amtec.com.vn

Customer: -

Drawing title:
AMTEC ROYAL-DC DATACENTER CABINET
48U 800x1000

Part No:
AMDC45-8100



Design by: Nguyễn Xuân Hùng Date: 06-03-2019

Checked by: Lê Hoàng Tuấn Date: 06-03-2019

Material: SPCC t= 1 to 2 Scale: 1:20

Sheet No:

Drawn by: Nguyễn Xuân Hùng Date: 06-03-2019

Approved by: Phan Quang Đức Date: 06-03-2019

Qty/Job: - Unit: mm

07

File name:

Drawing No: 02

FRONT VIEW

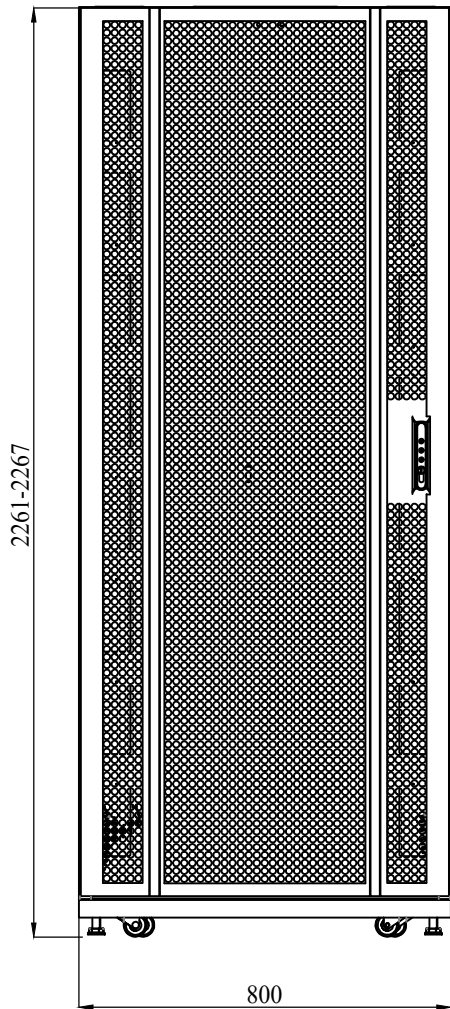

**FRONT VIEW
(REMOVED DOOR)**

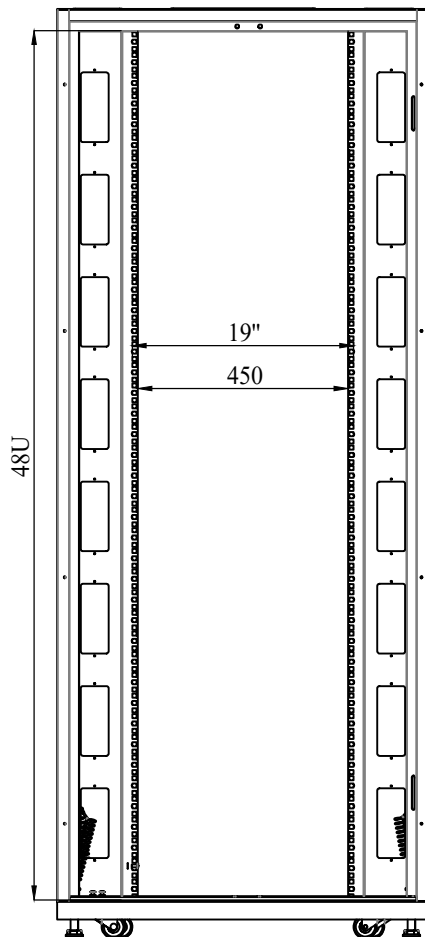

REAR VIEW

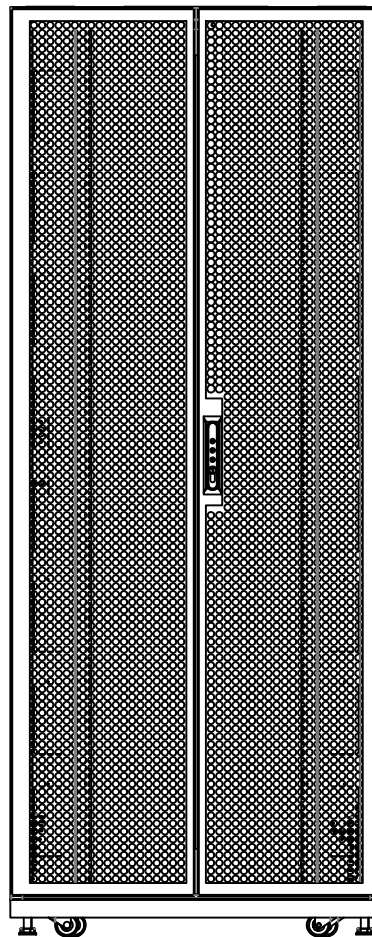

SIDE VIEW

3

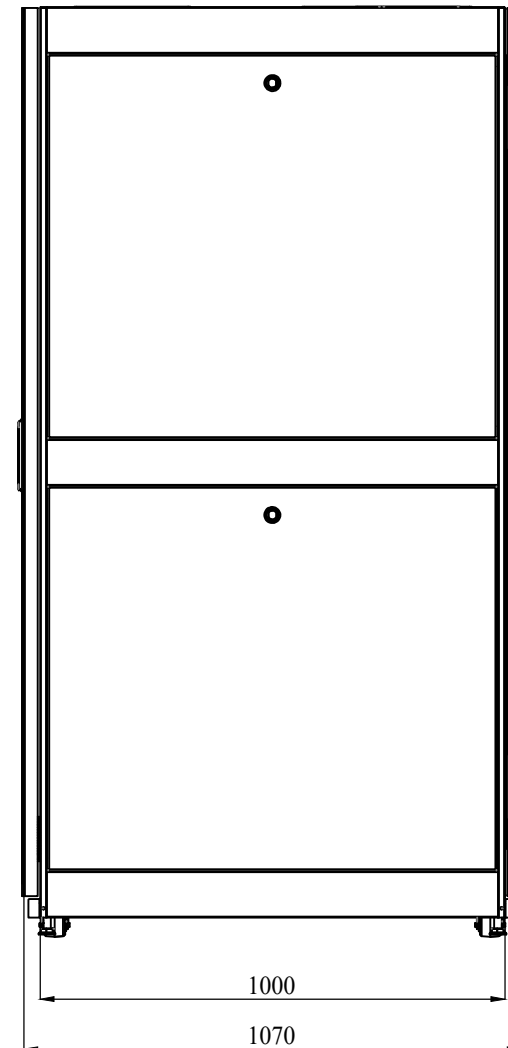

ANH MINH TECHNOLOGY COMPANY LIMITED-AMTEC CO.,LTD
 17/3, Binh Quoi A, Binh Chuan, Thuan An, Binh Duong, Viet Nam
 Tel: (84-274) 3612177 Fax: (84-274) 3612178
 Email: info@amtec.com.vn Web: www.amtec.com.vn

Customer:	-	Drawing title:	AMTEC ROYAL-DC DATACENTER CABINET 48U 800x1000		Part No:	AMDC48-8100							
Design by:	Nguyễn Xuân Hùng	Date:	06-03-2019	Checked by:	Lê Hoàng Tuấn	Date:	06-03-2019		Material:	SPCC t=1.0 2	Scale:	1:15	Sheet No:
Drawn by:	Nguyễn Xuân Hùng	Date:	06-03-2019	Approved by:	Phan Quang Đức	Date:	06-03-2019	Qty/Job:	-	Unit:	mm		
File name:				Drawing No:	03								

TOP VIEW

BOTTOM VIEW

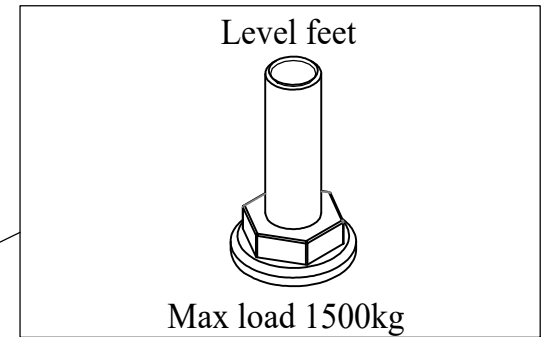
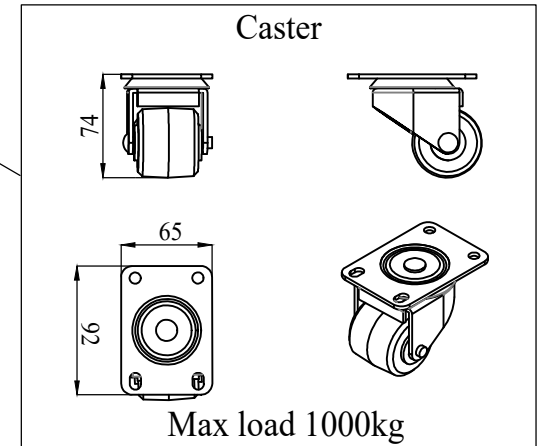
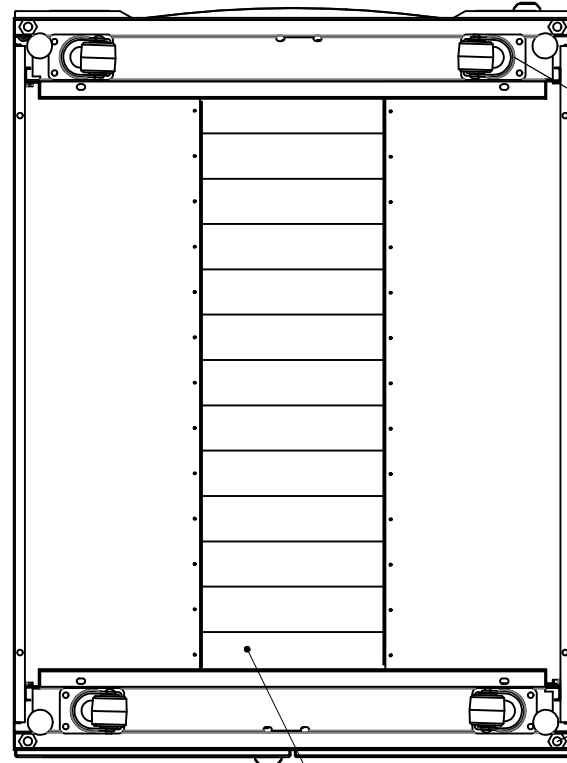
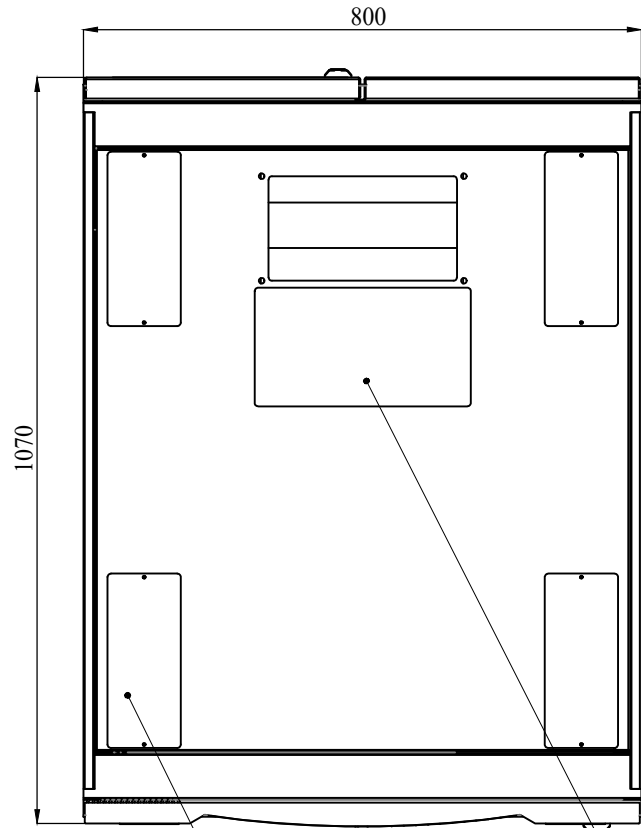

Cable hole 100x240 (4x)

Cable hole 150x270 (2x)

Cable hole 60x270



ANH MINH TECHNOLOGY COMPANY LIMITED-AMTEC CO.,LTD
 17/3, Binh Quoi A, Binh Chuan, Thuan An, Binh Duong, Viet Nam
 Tel: (84-274) 3612177 Fax: (84-274) 3612178
 Email: info@amtec.com.vn Web: www.amtec.com.vn

Customer:	-
Design by:	Nguyễn Xuân Hùng
Date:	06-03-2019
Drawn by:	Nguyễn Xuân Hùng
Date:	06-03-2019
File name:	

Drawing title:	AMTEC ROYAL-DC DATACENTER CABINET 48U 800x1000
Checked by:	Lê Hoàng Tuấn
Date:	06-03-2019
Approved by:	Phan Quang Đức
Date:	06-03-2019

Part No:	AMDC48-8100
Material:	SPCC t=1 to 2
Scale:	1:10
Qty/Job:	-
Unit:	mm
Drawing No:	04

Sheet No:	07

DETAIL ITEM: 5-9-10

5

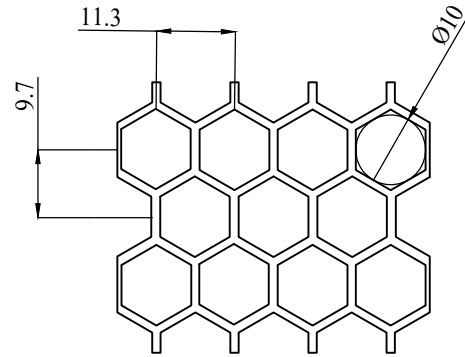
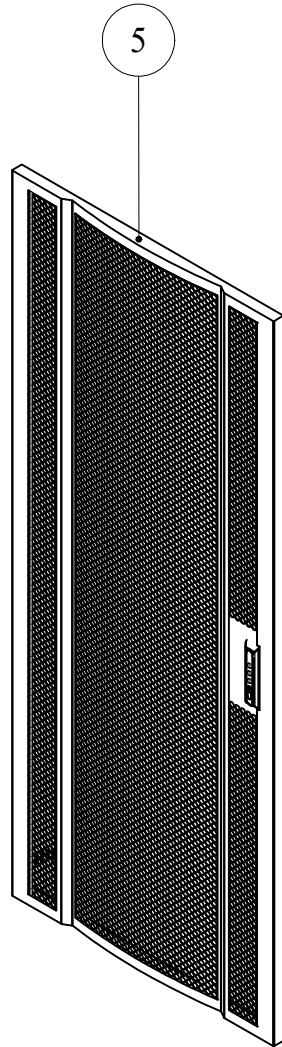

>80% HEXAGON PERFORATED DOOR

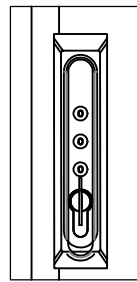

SWINGHANDLE KEY

9

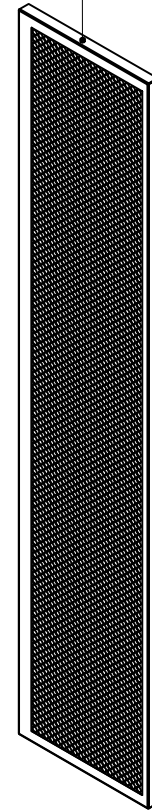

10

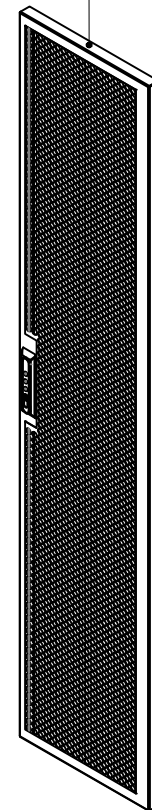

ANH MINH TECHNOLOGY COMPANY LIMITED-AMTEC CO.,LTD
 17/3, Binh Quoi A, Binh Chuan, Thuan An, Binh Duong, Viet Nam
 Tel: (84-274) 3612177 Fax: (84-274) 3612178
 Email: info@amtec.com.vn Web: www.amtec.com.vn

Customer:	-
Design by:	Nguyễn Xuân Hùng
Drawn by:	Nguyễn Xuân Hùng
File name:	

Drawing title:	AMTEC ROYAL-DC DATACENTER CABINET 48U 800x1000
Checked by:	Lê Hoàng Tuấn
Approved by:	Phan Quang Đức

Part No:	AMDC48-8100
Material:	SPCC t=1 to 2
Qty/Job:	-
Drawing No:	05

	Scale: 1:15
Unit: mm	Sheet No: 07

DETAIL ITEM: 3-4

6

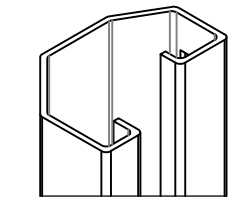
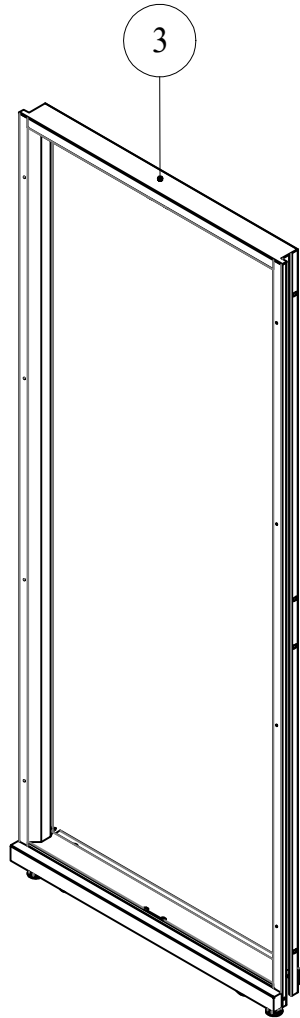

XTRUK 9 SIDES
MAX LOAD 1500kg

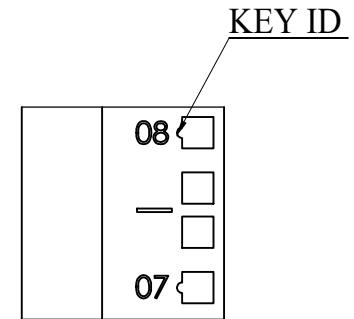
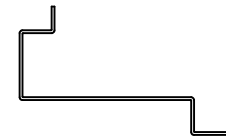
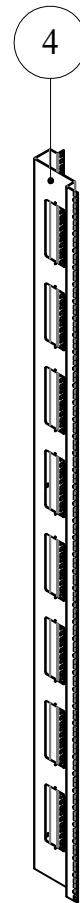

MOUNTING PROFILE
WITH KEY ID&U-HIGH
NUMBERING

Thanh bắt thiết bị 6 cạnh vững chắc
và được đánh số rõ ràng từng U từ thấp đến cao



ANH MINH TECHNOLOGY COMPANY LIMITED-AMTEC CO.,LTD
17/3, Binh Quoi A, Binh Chuan, Thuan An, Binh Duong, Viet Nam
Tel: (84-274) 3612177 Fax: (84-274) 3612178
Email: info@amtec.com.vn Web: www.amtec.com.vn

Customer:	-	Drawing title:	AMTEC ROYAL-DC DATACENTER CABINET 48U 800x1000	Part No:	AMDC48-8100								
Design by:	Nguyễn Xuân Hùng	Date:	06-03-2019	Checked by:	Lê Hoàng Tuấn		Date:	06-03-2019	Material:	SPCC t=1 to 2	Scale:	1:15	Sheet No:
Drawn by:	Nguyễn Xuân Hùng	Date:	06-03-2019	Approved by:	Phan Quang Đức	Date:	06-03-2019	Qty/Job:	-	Unit:	mm		
File name:				Drawing No:	06								

ISOMETRIC VIEW

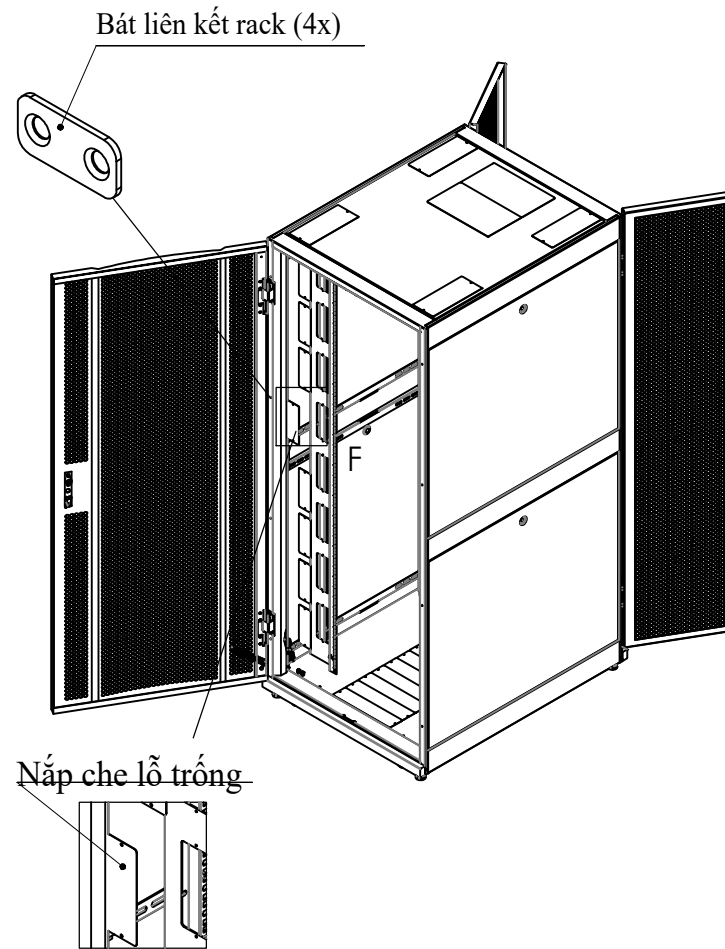

DETAIL F
SCALE 1 : 10

TOP VIEW

⑦

Góc mở cửa trước và sau 120 độ

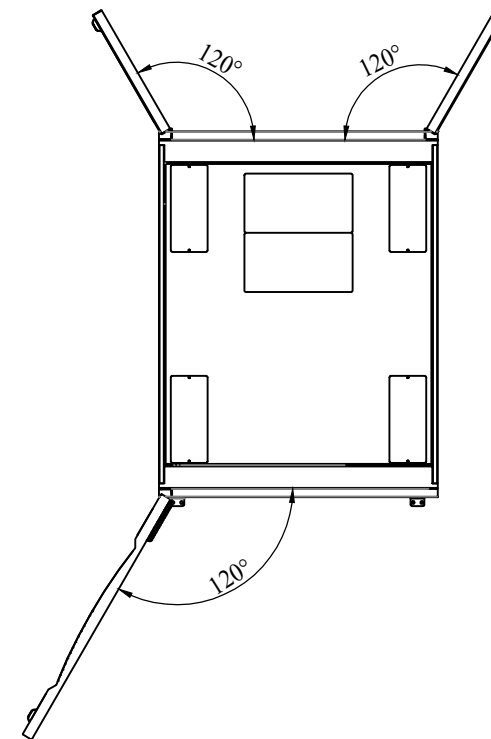

ANH MINH TECHNOLOGY COMPANY LIMITED-AMTEC CO.,LTD
17/3, Binh Quoi A, Binh Chuan, Thuan An, Binh Duong, Viet Nam
Tel: (84-274) 3612177 Fax: (84-274) 3612178
Email: info@amtec.com.vn Web: www.amtec.com.vn

Customer:	-	Drawing title:	AMTEC ROYAL-DC DATACENTER CABINET 48U 800x1000		Part No:	AMDC48-8100							
Design by:	Nguyễn Xuân Hùng	Date:	06-03-2019	Checked by:	Lê Hoàng Tuấn	Date:		06-03-2019	Material:	SPCC t=1 to 2	Scale:	1:25	Sheet No:
Drawn by:	Nguyễn Xuân Hùng	Date:	06-03-2019	Approved by:	Phan Quang Đức	Date:	06-03-2019	Qty/Job:	-	Unit:	mm		
File name:					Drawing No:	07							