

FRONT&RIGHT VIEW

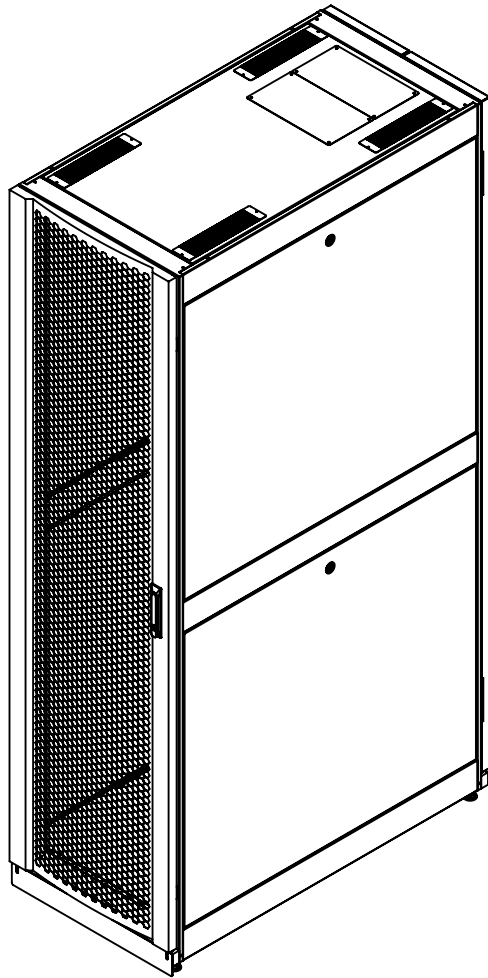

REAR&LEFT VIEW

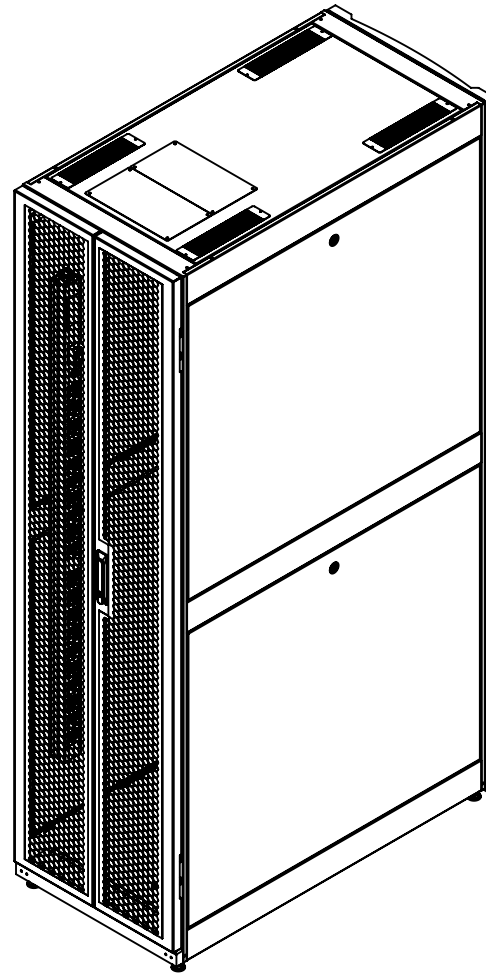

Thông số kỹ thuật:

1	Tiêu chuẩn	- ISO 9001:2015 - ISO 14001:2015 - CE, EN/IEC 62368-1, RoHS - ANSI/EIA 310-D, phần A - DIN 41494 - BS5954 phần 2 - IEC 60297-1, IEC 60297-2 - IP20
2	Vật liệu	- Thép Posso/JSVC - SPCC/SD
3	Tải trọng	.Trên các bánh xe 1300 kg. .Trên các chân đế 2000kg.
4	Màu sơn	Sơn tĩnh điện màu đen
5	Độ thông thoáng	Cửa lưới lục giác trước&sau thông thoáng >80%



ANH MINH TECHNOLOGY COMPANY LIMITED-AMTEC CO.,LTD
17/3, Binh Quoi A, Binh Chuan, Thuan An, Binh Duong, Viet Nam
Tel: (84-650) 3612177 Fax: (84-650) 3612178
Email: info@amtec.com.vn Web: www.amtec.com.vn

Customer:	-	Drawing title:	AMTEC Royal-DC® DATACENTER CABINET 48U 600x1200		Part No:	AM-DC48-6120			
Design by:	HUỖNH HỮU AN	Date:	10-Apr-25	Checked by:	LÊ HOÀNG TUẤN	Date:			Sheet No: 8
Drawn by:	HUỖNH HỮU AN	Date:	10-Apr-25	Approved by:	PHAN QUANG ĐỨC	Date:			
File name:	-			Material:	SPCC t=1.0 to 2.0	Scale:	1:20		
				Qty/Job:	-	Unit:	mm		
				Drawing No:	1				

EXPLODE VIEW

E
1:5

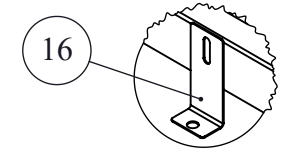

Khóa cửa hông(4x)
Dùng chung chìa cửa trước và sau

A
1:4



D
1:6

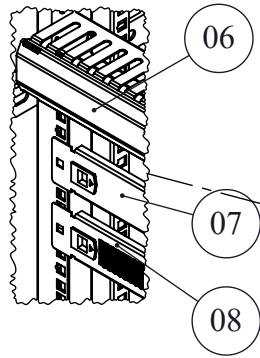

Khóa tay nắm
Dùng chung chìa
cửa trước và sau

B
1:5

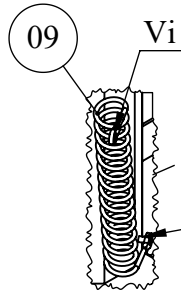

Điểm bắt tiếp đất chính
Điểm bắt chống tĩnh điện ESD

Chân cân bằng

Item	Name	Q'Ty	Thick	Description
01	Nóc	1	1.2	
02	Thanh nối dọc	6	2.0	
03	Khung	2	2.0	
04	Thanh lắp thiết bị	4	2.0	
05	Cửa trước	1	1.2	Thép, Uốn cong, >80% Thoáng khí
06	Quản lý cáp ngang	3		Thép
07	Tấm bịt trước 1U	15	1.0	
08	Tấm bịt trước luồn cáp 1U	2	1.0	
09	Dây mát từ	3		Tiết diện 4.0 mm ²
10	Bánh xe & chân cân bằng	4		
11	Tấm bịt mặt trước chân	1	1.0	Thép
12	Cửa hông	4	1.0	Thép
13	Thanh lắp PDU dọc	2	1.0	4 PDU
14	Cửa sau trái	1	1.2	Thép, >80% Thoáng khí
15	Cửa sau phải	1	1.2	Thép, >80% Thoáng khí
16	Bộ bắt sàn nâng	4	1.0	
17	Bàn chải chống thoát nhiệt	4	1.0	

amtec
ANH MINH TECHNOLOGY COMPANY LIMITED-AMTEC CO.,LTD
17/3, Binh Quoi A, Binh Chuan, Thuan An, Binh Duong, Viet Nam
Tel: (84-650) 3612177 Fax: (84-650) 3612178
Email: info@amtec.com.vn Web: www.amtec.com.vn

Customer: -
Design by: **HUỖNH HỮU AN** Date: 10-Apr-25
Drawn by: **HUỖNH HỮU AN** Date: 10-Apr-25
File name: -

Drawing title:
**AMTEC Royal-DC® DATACENTER CABINET
48U 600x1200**
Checked by: **LÊ HOÀNG TUẤN** Date:
Approved by: **PHAN QUANG ĐỨC** Date:

Part No:
AM-DC48-6120
Material: **SPCC t=1.0 to 2.0** Scale: **1:27**
Qty/Job: - Unit: **mm**
Drawing No: **2**

Sheet No:
8

FRONT VIEW

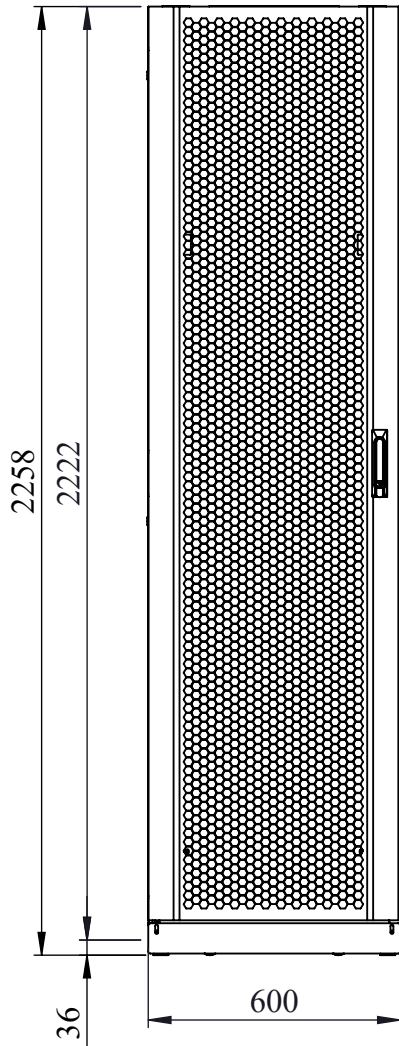

FRONT VIEW (REMOVED DOOR)

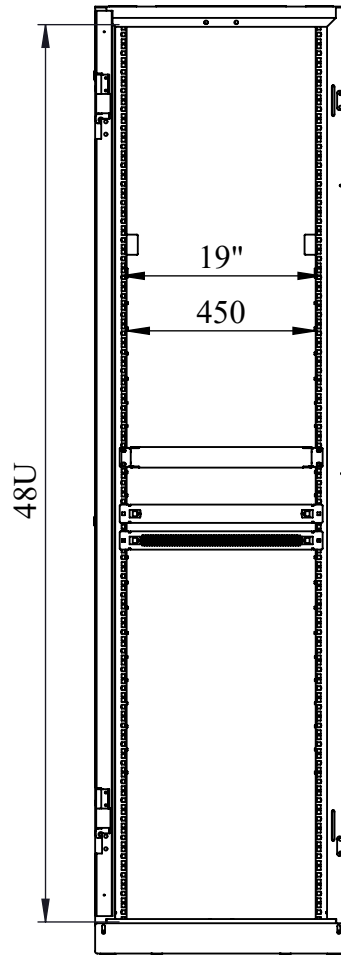

REAR VIEW

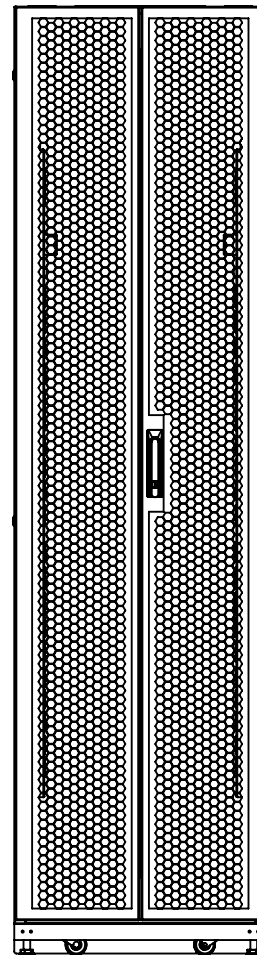

SIDE VIEW (REMOVED 1SIDE DOOR)

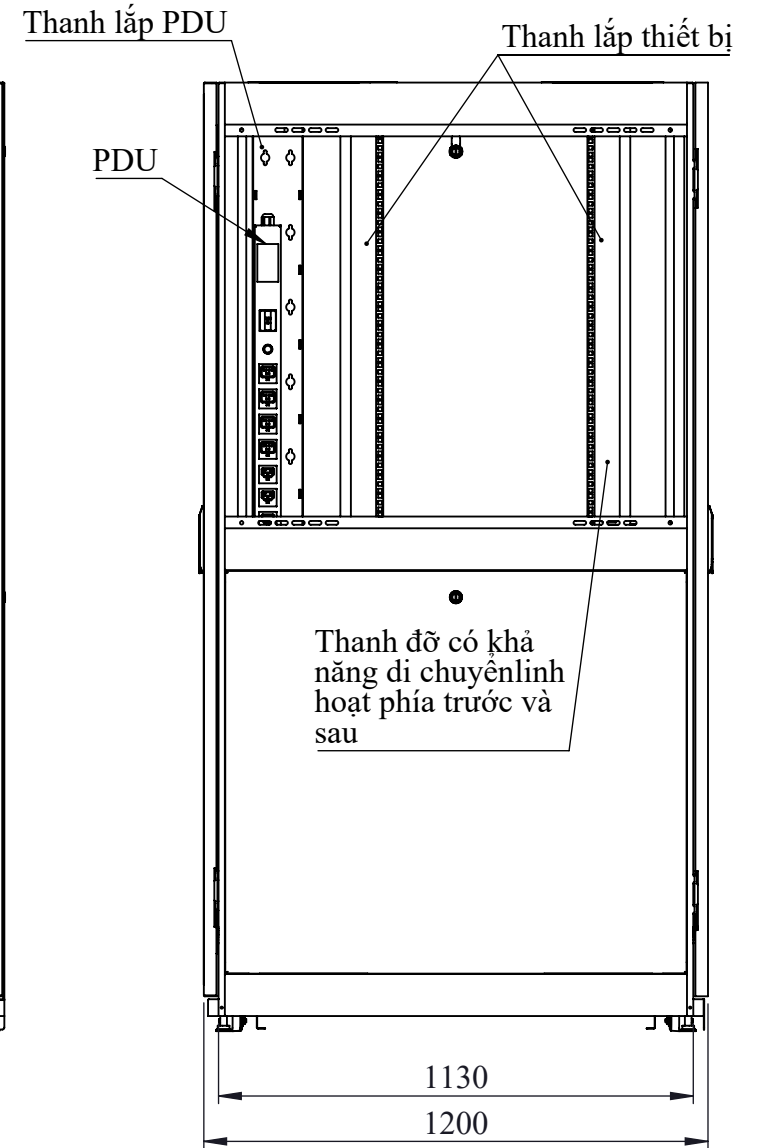

ANH MINH TECHNOLOGY COMPANY LIMITED-AMTEC CO.,LTD
 17/3, Binh Quoi A, Binh Chuan, Thuan An, Binh Duong, Viet Nam
 Tel: (84-650) 3612177 Fax: (84-650) 3612178
 Email: info@amtec.com.vn Web: www.amtec.com.vn

Customer: -
Design by: HUỖNH HỮU AN **Date:** 10-Apr-25
Drawn by: HUỖNH HỮU AN **Date:** 10-Apr-25
File name: -

Drawing title:
 AMTEC Royal-DC® DATACENTER CABINET
 48U 600x1200
Checked by: LÊ HOÀNG TUẤN **Date:** -
Approved by: PHAN QUANG ĐỨC **Date:** -

Part No:
 AM-DC48-6120
Material: SPCC t=1.0 to 2.0
Qty/Job: -
Drawing No: 3

Sheet No:
 8

TOP VIEW

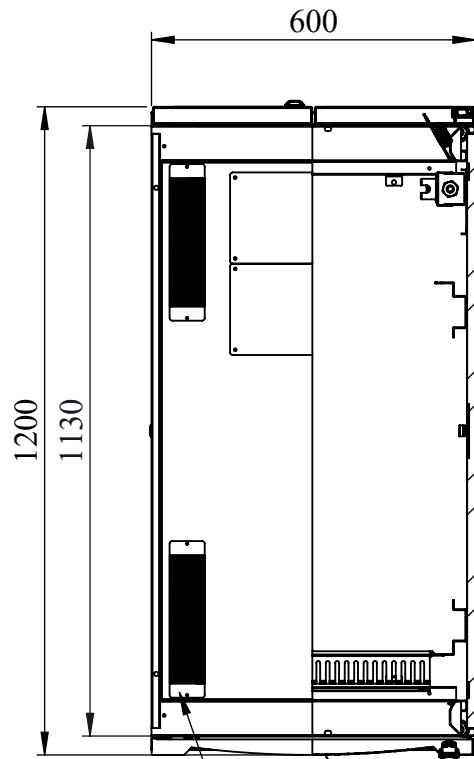

Cửa trước uốn cong

Lỗ cấp KT 60x270mm (4x)
có bản chải che thoát nhiệt

BOTTOM VIEW

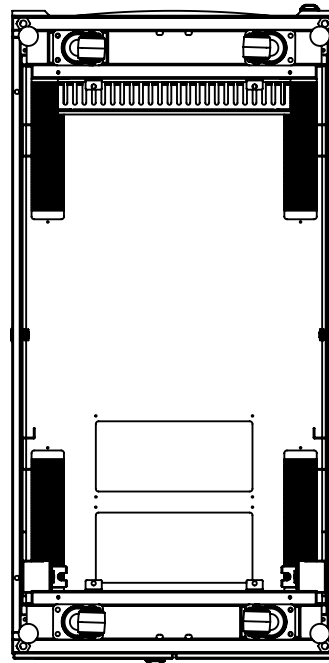

BÁNH XE x4

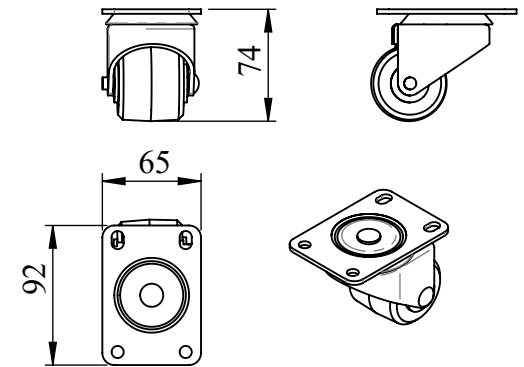

Max load 1300kg

CHÂN CÂN BẰNG x4

Điều chỉnh độ cao từ
10mm

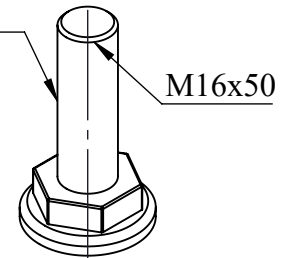

Max load 2000kg



ANH MINH TECHNOLOGY COMPANY LIMITED-AMTEC CO.,LTD
17/3, Binh Quoi A, Binh Chuan, Thuan An, Binh Duong, Viet Nam
Tel: (84-650) 3612177 Fax: (84-650) 3612178
Email: info@amtec.com.vn Web: www.amtec.com.vn

Customer:	-
Design by: HUỖNH HỮU AN	Date: 10-Apr-25
Drawn by: HUỖNH HỮU AN	Date: 10-Apr-25
File name:	-

Drawing title:	AMTEC Royal-DC® DATACENTER CABINET 48U 600x1200
Checked by: LÊ HOÀNG TUẤN	Date:
Approved by: PHAN QUANG ĐỨC	Date:

Part No:	AM-DC48-6120
Material: SPCC t=1.0 to 2.0	Scale: 1:14
Qty/Job: -	Unit: mm
Drawing No:	4

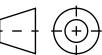

Sheet No:
8

CỬA TRƯỚC

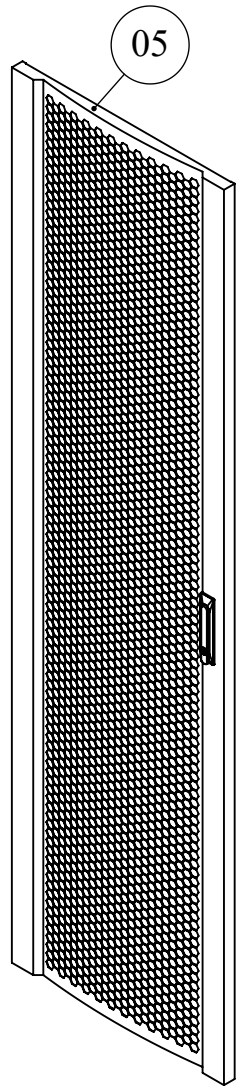

DETAIL ITEM:

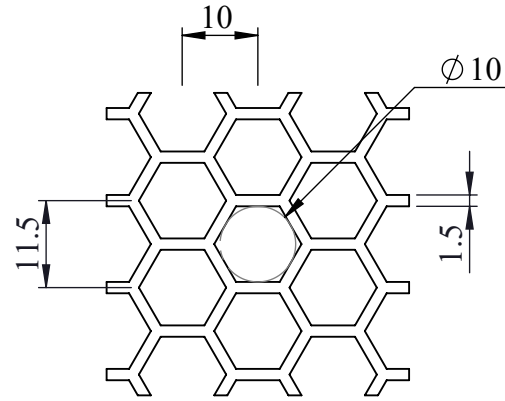

DETAIL A: Hình lục giác
>80% thông thoáng khí

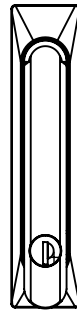

KHÓA TAY NẮM
(Khóa và tay cầm chốt dạng gạt)
Dùng chung chia cửa trước, sau và cửa hông

CỬA SAU

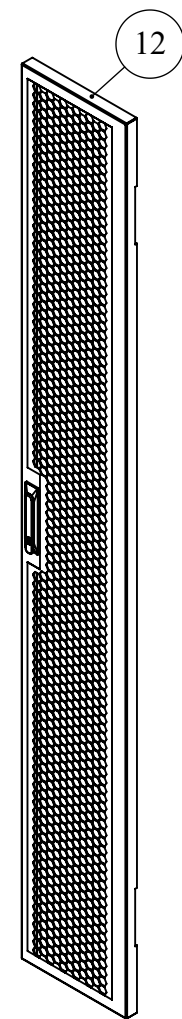
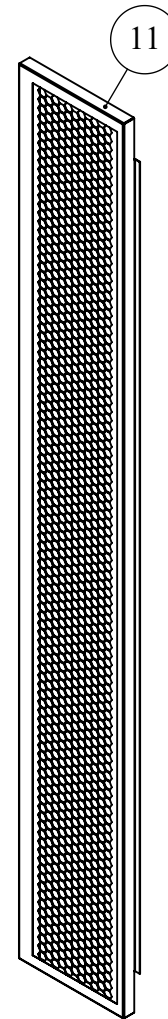

ANH MINH TECHNOLOGY COMPANY LIMITED-AMTEC CO.,LTD
17/3, Binh Quoi A, Binh Chuan, Thuan An, Binh Duong, Viet Nam
Tel: (84-650) 3612177 Fax: (84-650) 3612178
Email: info@amtec.com.vn Web: www.amtec.com.vn

Customer:	-	Drawing title:	AMTEC Royal-DC® DATACENTER CABINET 48U 600x1200		Part No:	AM-DC48-6120								
Design by:	HUỖNH HỮU ẮN	Date:	10-Apr-25	Checked by:	LÊ HOẮNG TUẮN	Date:	-		Material:	SPCC t=1.0 to 2.0	Scale:	1:15	Sheet No:	8
Drawn by:	HUỖNH HỮU ẮN	Date:	10-Apr-25	Approved by:	PHAN QUANG ĐỨC	Date:	-		Qty/Job:	-	Unit:	mm		
File name:	-								Drawing No:	5				

DETAIL ITEM:

KHUNG

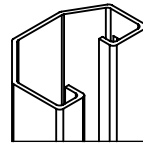
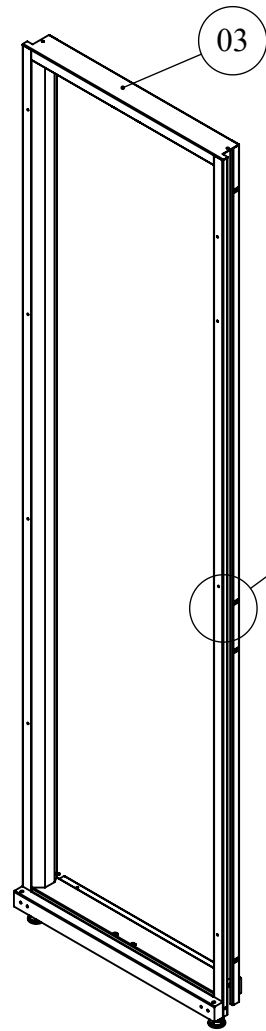

XTRUK 9 SIDES
MAX LOAD 2000kg

THANH LẮP THIẾT BỊ

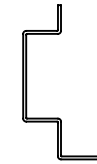
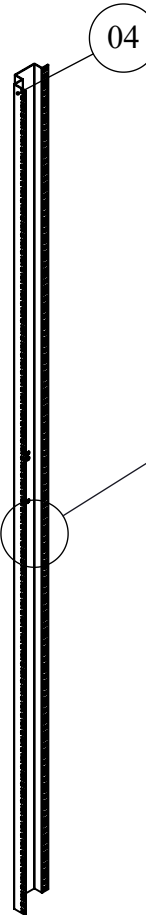

U-HIGH
NUMBERING

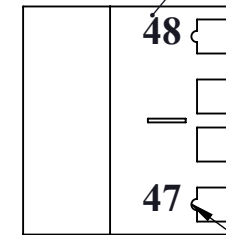

KEY ID

MOUNTING PROFILE



ANH MINH TECHNOLOGY COMPANY LIMITED-AMTEC CO.,LTD
17/3, Binh Quoi A, Binh Chuan, Thuan An, Binh Duong, Viet Nam
Tel: (84-650) 3612177 Fax: (84-650) 3612178
Email: info@amtec.com.vn Web: www.amtec.com.vn

Customer:	-	Drawing title:	AMTEC Royal-DC® DATACENTER CABINET 48U 600x1200	Part No:	AM-DC48-6120									
Design by:	HUỖNH HỮU AN	Date:	10-Apr-25	Checked by:	LÊ HOÀNG TUẤN		Date:		Material:	SPCC t=1.0 to 2.0	Scale:	1:16	Sheet No:	8
Drawn by:	HUỖNH HỮU AN	Date:	10-Apr-25	Approved by:	PHAN QUANG ĐỨC		Date:		Qty/Job:	-	Unit:	mm		
File name:	-			Drawing No:	6									

ISOMETRIC VIEW

TOP VIEW

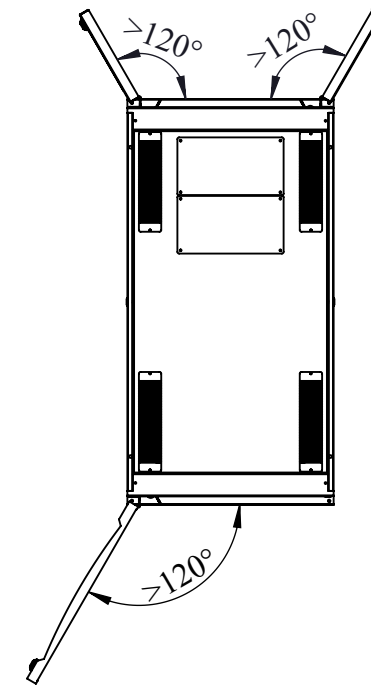
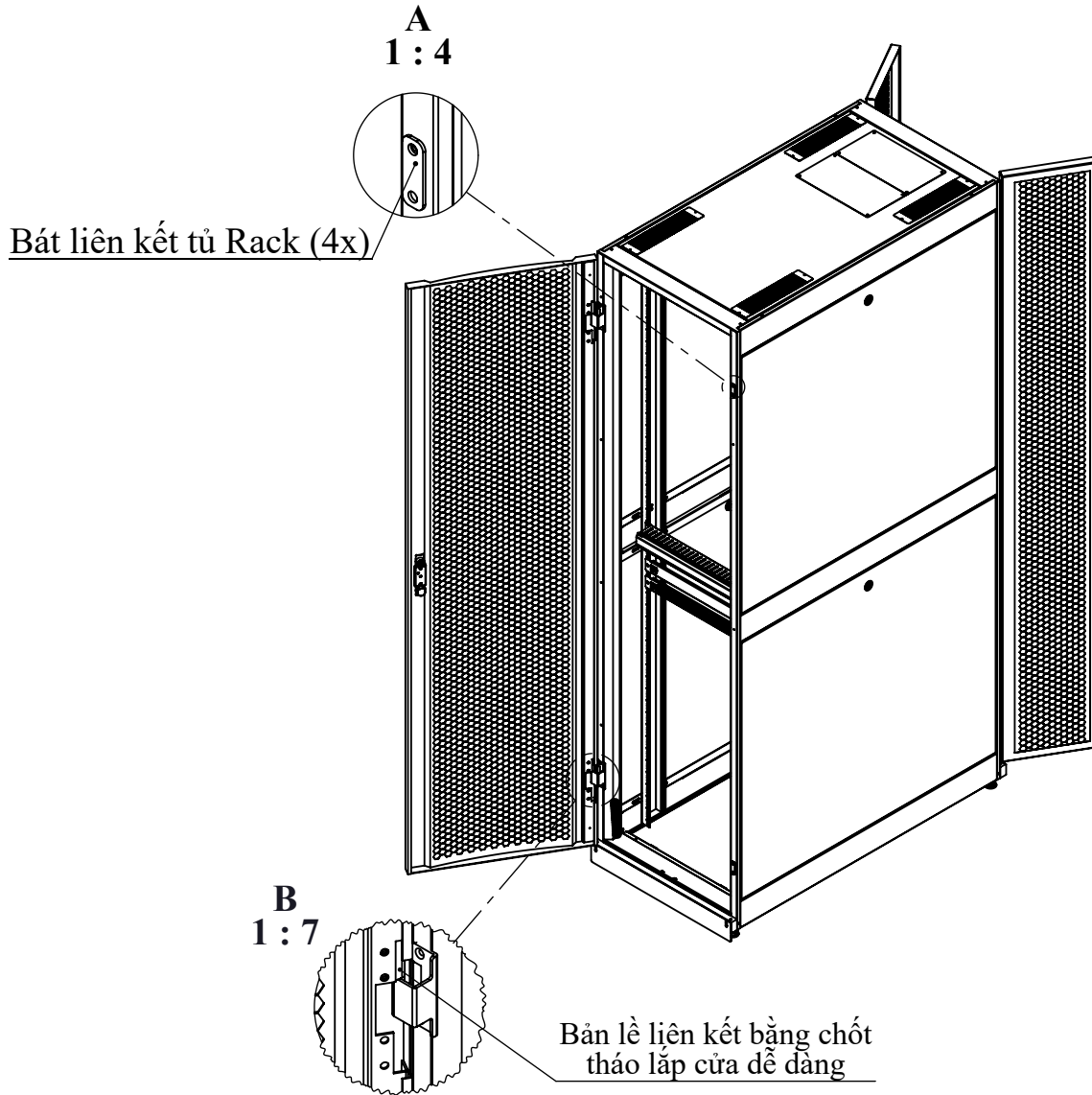

ANH MINH TECHNOLOGY COMPANY LIMITED-AMTEC CO.,LTD
17/3, Binh Quoi A, Binh Chuan, Thuan An, Binh Duong, Viet Nam
Tel: (84-650) 3612177 Fax: (84-650) 3612178
Email: info@amtec.com.vn Web: www.amtec.com.vn

Customer:	-	Drawing title:	AMTEC Royal-DC® DATACENTER CABINET 48U 600x1200		Part No:	AM-DC48-6120								
Design by:	HUỖNH HỮU AN	Date:	10-Apr-25	Checked by:	LÊ HOÀNG TUẤN	Date:	-		Material:	SPCC t=1.0 to 2.0	Scale:	1:22	Sheet No:	8
Drawn by:	HUỖNH HỮU AN	Date:	10-Apr-25	Approved by:	PHAN QUANG ĐỨC	Date:	-		Qty/Job:	-	Unit:	mm		
File name:	-			Drawing No:	7									

PHỤ KIỆN:

NẮP BỊT 1U VÀ NẮP BỊT LUỒN CÁP 1U

- Thép cán nguội SPCC dày 1mm
- Xử lý sạch bề mặt trước khi sơn.
- Sơn tĩnh điện nhẵn bóng, cùng màu sơn với tủ rack.
- Dễ lắp đặt/tháo rời.
- Loại gài gắn không cần dụng cụ.

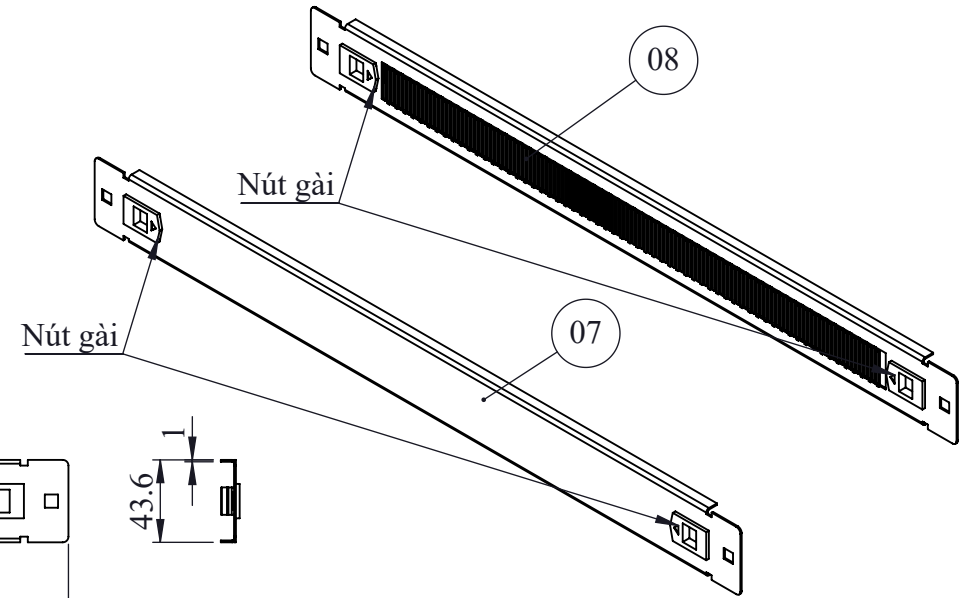
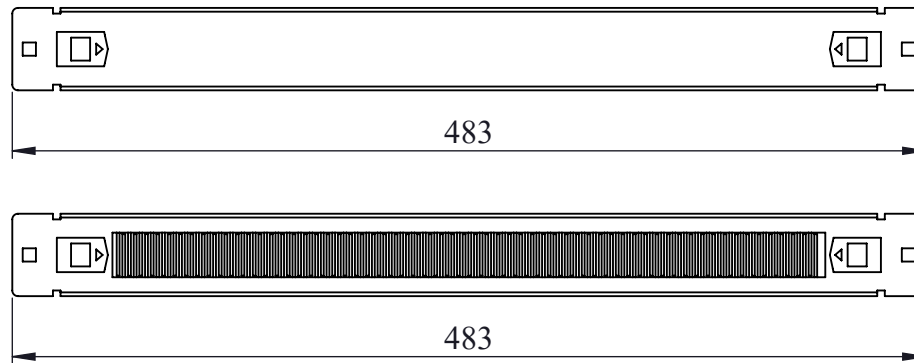

QUẢN LÝ CÁP NGANG

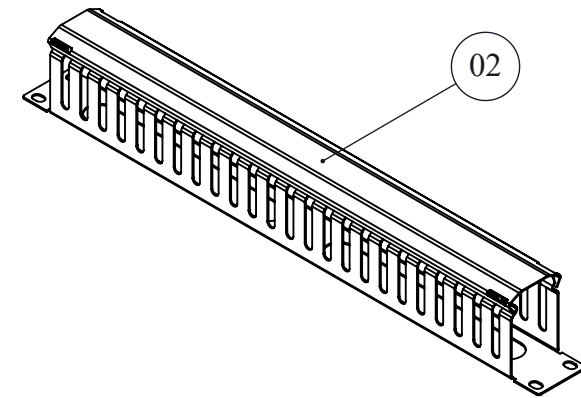
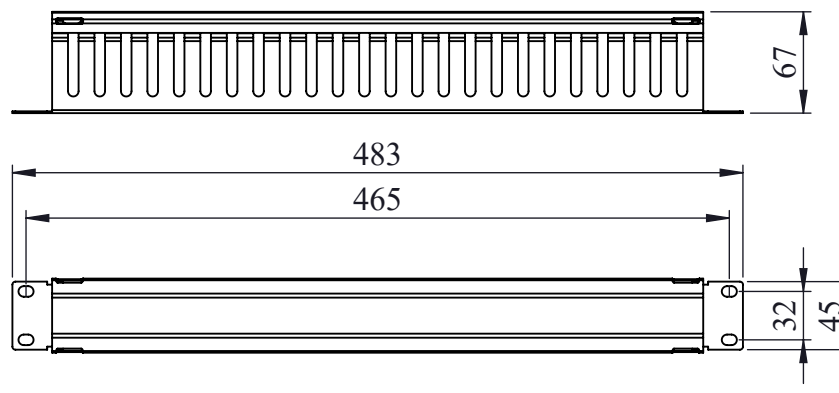

ANH MINH TECHNOLOGY COMPANY LIMITED-AMTEC CO.,LTD
17/3, Binh Quoi A, Binh Chuan, Thuan An, Binh Duong, Viet Nam
Tel: (84-650) 3612177 Fax: (84-650) 3612178
Email: info@amtec.com.vn Web: www.amtec.com.vn

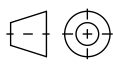
Customer:	-	Drawing title:	AMTEC Royal-DC® DATACENTER CABINET 48U 600x1200		Part No:	AM-DC48-6120	 Sheet No: 8	
Design by:	HUỲNH HỮU AN	Date:	10-Apr-25	Checked by:	LÊ HOÀNG TUẤN	Date:		
Drawn by:	HUỲNH HỮU AN	Date:	10-Apr-25	Approved by:	PHAN QUANG ĐỨC	Date:		
File name:	-			Material:	SPCC t=1.0 to 2.0	Scale:		1:4
				Qty/Job:	-	Unit:	mm	
				Drawing No:	8			